

**SAMSUNG**



COLOR LASER PRINTER User's Guide

# CLP-650 Series

This manual is provided for information purposes only. All information included herein is subject to change without notice. Samsung Electronics is not responsible for any changes, direct or indirect, arising from or related to use of this manual.  
© 2005 Samsung Electronics Co., Ltd. All rights reserved.

- CLP-650 and CLP-650N are model names of Samsung Electronics Co., Ltd.
- SAMSUNG and Samsung logo are trademarks of Samsung Electronics co., Ltd.
- Apple, TrueType, Laser Writer, and Macintosh are Trademarks of Apple Computer, Inc.
- Microsoft, Windows, Windows 98SE, Windows Me, Windows 2000, Windows 2003, Windows NT 4.0, and Windows XP are registered trademarks of Microsoft Corporation.
- All other brand or product names are trademarks of their respective companies or organizations.

# Contact SAMSUNG WORLD WIDE

If you have any comments or questions regarding Samsung products, contact the SAMSUNG customer care center.

Country	Customer Care Center	Web Site
CANADA	1-800-SAMSUNG (7267864)	www.samsung.com/ca
MEXICO	01-800-SAMSUNG (7267864)	www.samsung.com/mx
U.S.A	1-800-SAMSUNG (7267864)	www.samsung.com
ARGENTINE	0800-333-3733	www.samsung.com/ar
BRAZIL	0800-124-421	www.samsung.com/br
CHILE	800-726-7864 (SAMSUNG)	www.samsung.com/cl
COSTA RICA	0-800-507-7267	www.samsung.com/latin
ECUADOR	1-800-10-7267	www.samsung.com/latin
EL SALVADOR	800-6225	www.samsung.com/latin
GUATEMALA	1-800-299-0013	www.samsung.com/latin
JAMAICA	1-800-234-7267	www.samsung.com/latin
PANAMA	800-7267	www.samsung.com/latin
PUERTO RICO	1-800-682-3180	www.samsung.com/latin
REP. DOMINICA	1-800-751-2676	www.samsung.com/latin
TRINIDAD & TOBAGO	1-800-7267-864	www.samsung.com/latin
VENEZUELA	1-800-100-5303	www.samsung.com/latin
BELGIUM	02 201 2418	www.samsung.com/be
CZECH REPUBLIC	844 000 844	www.samsung.com/cz
DENMARK	38 322 887	www.samsung.com/dk
FINLAND	09 693 79 554	www.samsung.com/fi
FRANCE	08 25 08 65 65 (€ 0,15/min)	www.samsung.com/fr
GERMANY	01805 - 121213 (€ 0,12/min)	www.samsung.de
HUNGARY	06 40 985 985	www.samsung.com/hu
ITALIA	199 153 153	www.samsung.com/it

Country	Customer Care Center	Web Site
LUXEMBURG	02 261 03 710	www.samsung.lu
NETHERLANDS	0900 20 200 88 (€ 0,10/min)	www.samsung.com/nl
NORWAY	231 627 22	www.samsung.com/no
POLAND	0 801 801 881	www.samsung.com/pl
PORTUGAL	80 8 200 128	www.samsung.com/pt
SLOVAKIA	0850 123 989	www.samsung.com/sk
SPAIN	902 10 11 30	www.samsung.com/es
SWEDEN	08 585 367 87	www.samsung.com/se
U.K	0870 242 0303	www.samsung.com/uk
RUSSIA	8-800-200-0400	www.samsung.ru
UKRAINE	8-800-502-0000	www.samsung.com/ur
AUSTRALIA	1300 362 603	www.samsung.com/au
CHINA	800-810-5858 010- 6475 1880	www.samsung.com.cn
HONG KONG	2862 6001	www.samsung.com/hk
INDIA	3030 8282 1600 1100 11	www.samsung.com/in
INDONESIA	0800-112-8888	www.samsung.com/id
JAPAN	0120-327-527	www.samsung.com/jp
MALAYSIA	1800-88-9999	www.samsung.com/my
PHILIPPINES	1800-10-SAMSUNG (7267864)	www.samsung.com/ph
SINGAPORE	1800-SAMSUNG (7267864)	www.samsung.com/sg
THAILAND	1800-29-3232 02-689-3232	www.samsung.com/th
TAIWAN	0800-329-999	www.samsung.com/tw
VIETNAM	1 800 588 889	www.samsung.com/vn
SOUTH AFRICA	0860 7267864 (SAMSUNG)	www.samsung.com/za
U.A.E	800SAMSUNG (7267864)	www.samsung.com/mea

# CONTENTS

## 1. Introduction

Special Features .....	1.1
Printer Components .....	1.3
Front View .....	1.3
Right Side View .....	1.3

## 2. Setting Up Your Printer

Unpacking .....	2.1
Installing the Toner Cartridges .....	2.2
Loading Paper .....	2.4
Changing the Size of the Paper in the Tray .....	2.5
Connecting a Printer Cable .....	2.7
For Local Printing .....	2.7
For Network Printing (CLP-650N only) .....	2.8
Turning the Printer On .....	2.8
Printing a Demo Page .....	2.8
Changing the Display Language .....	2.9
Installing the Printer Software .....	2.9
System Requirements .....	2.9
Printer Driver Features .....	2.10

## 3. Using the Control Panel

Understanding the Control Panel .....	3.1
Display .....	3.1
Buttons .....	3.2
Using Control Panel Menus .....	3.3
Accessing Control Panel Menus .....	3.3
Overview of Control Panel Menus .....	3.3
Information Menu .....	3.4
Paper Menu .....	3.4
Printer Menu .....	3.6
Setup Menu .....	3.6
PCL Menu .....	3.7
PostScript Menu .....	3.7
Network Menu (CLP-650N only) .....	3.8

## 4. Using Print Materials

Choosing Paper and Other Materials .....	4.1
Sizes and Capacities .....	4.1
Guidelines for Paper and Special Materials .....	4.1
Loading Paper .....	4.2
Using Tray1 .....	4.2
Using the Optional Tray .....	4.2
Using the Multi-purpose Tray .....	4.2
Using the Manual Feed .....	4.3
Printing on Special Print Materials .....	4.4
Printing on Envelopes .....	4.4
Printing on Labels .....	4.5
Printing on Preprinted Paper .....	4.5
Printing on Card Stock or Custom-sized Materials .....	4.6

## 5. Basic Printing

Printing a Document .....	5.1
Canceling a Print Job .....	5.1

## 6. Maintaining Your Printer

Printing a Configuration Page .....	6.1
Replacing Supplies .....	6.2
Managing Toner Cartridges .....	6.2
Toner Cartridge Storage .....	6.2
Toner Cartridge Life Expectancy .....	6.2
Redistributing Toner .....	6.2
Replacing Toner Cartridges .....	6.4
Replacing the Paper Transfer Belt .....	6.5
Replacing the Fuser Unit .....	6.7
Cleaning the Printer .....	6.8
Cleaning the Outside of the Printer .....	6.8
Cleaning the Inside of the Printer .....	6.8
Managing your Printer from the Website .....	6.9

## 7. Solving Problems

Troubleshooting Checklist .....	7.1
Solving General Printing Problems .....	7.2
Clearing Paper Jams .....	7.4
In the Paper Feed Area .....	7.4
In the Multi-purpose Tray .....	7.5
Inside the Printer .....	7.6
In the Paper Exit Area .....	7.7
In the Optional Tray2 .....	7.9
Tips for Avoiding Paper Jams .....	7.12
Solving Print Quality Problems .....	7.12
Understanding Display Messages .....	7.14
Common Windows Problems .....	7.17
Common Macintosh Problems .....	7.17
Common PS Errors .....	7.17
Common Linux Problems .....	7.18

## 8. Using Your Printer on a Network (CLP-650N only)

About Sharing the Printer on a Network .....	8.1
Setting Up a Network-Connected Printer .....	8.1
Configuring Network Parameters on the Control Panel .....	8.1

## 9. Installing Printer Options

Precautions When Installing Printer Options .....	9.1
Installing an Optional Paper Tray .....	9.1
Installing a memory DIMM .....	9.2
Activating the added memory in the PS printer properties .....	9.4

## 10. Specifications

Printer Specifications .....	10.1
Paper Specifications .....	10.1
Overview .....	10.1
Supported Sizes of Paper .....	10.2
Guidelines for Using Paper .....	10.2
Paper Specifications .....	10.3
Paper Output Capacity .....	10.3
Paper Input Capacity .....	10.3
Printer and Paper Storage Environment .....	10.3
Envelopes .....	10.4
Labels .....	10.4

## Important Precautions and Safety Information

When using this machine, these basic safety precautions should always be followed to reduce risk of fire, electric shock, and injury to people:

- 1 Read and understand all instructions.
- 2 Use common sense whenever operating electrical appliances.
- 3 Follow all warnings and instructions marked on the machine and in the literature accompanying the machine.
- 4 If an operating instruction appears to conflict with safety information, heed the safety information. You may have misunderstood the operating instruction. If you cannot resolve the conflict, contact your sales or service representative for assistance.
- 5 Unplug the machine from the AC wall socket before cleaning. Do not use liquid or aerosol cleaners. Use only a damp cloth for cleaning.
- 6 Do not place the machine on an unstable cart, stand or table. It may fall, causing serious damage.
- 7 Your machine should never be placed on, near or over a radiator, heater, air conditioner or ventilation duct.
- 8 Do not allow anything to rest on the power cable. Do not locate your machine where the cords will be abused by persons walking on them.
- 9 Do not overload wall outlets and extension cords. This can diminish performance, and may result in the risk of fire or electric shock.
- 10 Do not allow pets to chew on the AC power or PC interface cords.
- 11 Never push objects of any kind into the machine through case or cabinet openings. They may touch dangerous voltage points, creating a risk of fire or shock. Never spill liquid of any kind onto or into the machine.
- 12 To reduce the risk of electric shock, do not disassemble the machine. Take it to a qualified service technician when repair work is required. Opening or removing covers may expose you to dangerous voltages or other risks. Incorrect reassembly could cause electric shock when the unit is subsequently used.
- 13 Unplug the machine from the PC and AC wall outlet, and refer servicing to qualified service personnel under the following conditions:
  - When any part of the power cord, plug, or connecting cable is damaged or frayed.
  - If liquid has been spilled into the machine.
  - If the machine has been exposed to rain or water.
  - If the machine does not operate properly after instructions have been followed.
  - If the machine has been dropped, or the cabinet appears damaged.
  - If the machine exhibits a sudden and distinct change in performance.
- 14 Adjust only those controls covered by the operating instructions. Improper adjustment of other controls may result in damage, and may require extensive work by a qualified service technician to restore the machine to normal operation.
- 15 Avoid using this machine during a lightning storm. There may be a remote risk of electric shock from lightning. If possible, unplug the AC power for the duration of the lightning storm.

16 If you continuously print multiple pages, the surface of the output tray may become hot. Be careful not to touch the surface, and keep children away from the surface.

17 SAVE THESE INSTRUCTIONS.

## Environmental and Safety Consideration

### Laser Safety Statement

The printer is certified in the U.S. to conform to the requirements of DHHS 21 CFR, chapter 1 Subchapter J for Class I(1) laser products, and elsewhere, is certified as a Class I laser product conforming to the requirements of IEC 825.

Class I laser products are not considered to be hazardous. The laser system and printer are designed so there is never any human access to laser radiation above a Class I level during normal operation, user maintenance, or prescribed service condition.

### WARNING

Never operate or service the printer with the protective cover removed from Laser/Scanner assembly. The reflected beam, although invisible, can damage your eyes. When using this product, these basic safety precautions should always be followed to reduce risk of fire, electric shock, and injury to persons:



### Ozone Safety



During normal operation, this machine produces ozone. The ozone produced does not present a hazard to the operator. However, it is advisable that the machine be operated in a well ventilated area.

If you need additional information about ozone, please contact your nearest Samsung dealer.

### Power Saver

This printer contains advanced energy conservation technology that reduces power consumption when it is not in active use.

When the printer does not receive data for an extended period of time, power consumption is automatically lowered.

## Recycling



Please recycle or dispose of packaging materials for this product in an environmentally responsible manner.

## Correct Disposal of This Product (Waste Electrical & Electronic Equipment)

(Applicable in the European Union and other European countries with separate collection systems)



This marking shown on the product or its literature, indicates that it should not be disposed with other household wastes at the end of its working life. To prevent possible harm to the environment or human health from uncontrolled waste disposal, please separate this from other types of wastes and recycle it responsibly to promote the sustainable reuse of material resources.

Household users should contact either the retailer where they purchased this product, or their local government office, for details of where and how they can take this item for environmentally safe recycling.

Business users should contact their supplier and check the terms and conditions of the purchase contract. This product should not be mixed with other commercial wastes for disposal.

## Radio Frequency Emissions

### FCC Regulations

This device complies with Part 15 of the FCC Rules. Operation is subject to the following two conditions:

- This device may not cause harmful interference, and
- This device must accept any interference received, including interference that may cause undesired operation.

This device has been tested and found to comply with the limits for a Class B digital device, pursuant to Part 15 of the FCC rules. These limits are designed to provide reasonable protection against harmful interference in a residential installation. This equipment generates, uses and can radiate radio frequency energy and, if not installed and used in accordance with the instructions, may cause harmful interference to radio communications. However, there is no guarantee that interference will not occur in a particular installation. If this equipment does cause harmful interference to radio or television reception, which can be determined by turning the equipment off and on, the user is encouraged to try to correct the interference by one or more of the following measures:

- Reorient or relocate the receiving antenna.
- Increase the separation between the equipment and receiver.
- Connect the equipment into an outlet on a circuit different from that to which the receiver is connected.
- Consult the dealer or an experienced radio/TV technician for help.

**CAUTION:** Changes or modifications not expressly approved by the manufacturer responsible for compliance could void the user's authority to operate the equipment.

## Canadian Radio Interference Regulations

This digital apparatus does not exceed the Class B limits for radio noise emissions from digital apparatus as set out in the interference-causing equipment standard entitled "Digital Apparatus", ICES-003 of the Industry and Science Canada.

Cet appareil numérique respecte les limites de bruits radioélectriques applicables aux appareils numériques de Classe B prescrites dans la norme sur le matériel brouilleur: "Appareils Numériques", ICES-003 édictée par l'Industrie et Sciences Canada.

## Declaration of Conformity (European Countries)

### Approvals and Certifications



The CE marking applied to this product symbolises Samsung Electronics Co., Ltd. Declaration of Conformity with the following applicable 93/68/EEC Directives of the European Union as of the dates indicated:

January 1, 1995: Council Directive 73/23/EEC Approximation of the laws of the member states related to low voltage equipment.

January 1, 1996: Council Directive 89/336/EEC (92/31/EEC), approximation of the laws of the Member States related to electromagnetic compatibility.

March 9, 1999: Council Directive 1999/5/EC on radio equipment and telecommunications terminal equipment and the mutual recognition of their conformity.

A full declaration, defining the relevant Directives and referenced standards can be obtained from your Samsung Electronics Co., Ltd. representative.

## Replacing the Fitted Plug (for UK Only)

### IMPORTANT

The mains lead for this machine is fitted with a standard (BS 1363) 13 amp plug and has a 13 amp fuse. When you change or examine the fuse, you must re-fit the correct 13 amp fuse. You then need to replace the fuse cover. If you have lost the fuse cover, do not use the plug until you have another fuse cover.

Please contact the people from you purchased the machine.

The 13 amp plug is the most widely used type in the UK and should be suitable. However, some buildings (mainly old ones) do not have normal 13 amp plug sockets. You need to buy a suitable plug adaptor. Do not remove the moulded plug.

### WARNING

**If you cut off the moulded plug, get rid of it straight away.**

**You cannot rewire the plug and you may receive an electric shock if you plug it into a socket.**

### IMPORTANT WARNING: You must earth this machine.

The wires in the mains lead have the following color code:

- Green and Yellow: Earth
- Blue: Neutral
- Brown: Live

If the wires in the mains lead do not match the colors marked in your plug, do the following:

You must connect the green and yellow wire to the pin marked by the letter “E” or by the safety ‘Earth symbol’ or colored green and yellow or green.

You must connect the blue wire to the pin which is marked with the letter “N” or colored black.

You must connect the brown wire to the pin which is marked with the letter “L” or colored red.

You must have a 13 amp fuse in the plug, adaptor, or at the distribution board.

## EU Declaration of Conformity (LVD,EMC)

For the following product :

Color Laser Beam Printer
(Product name)
CLP-650, CLP-650N
(Model Number)

Manufactured at :

Samsung Electronics Co.,Ltd. #259, Gongdan-Dong, Gumi-City, Gyungbuk, KOREA. 730-030
(factory name, address)

We hereby declare, that all major safety requirements, concerning to CE Marking Directive[93/68/EEC] and Low Voltage Directive [73/23/EEC], ElectroMagnetic Compatibility [89/336/EEC], amendments [92/31/EEC] are fulfilled, as laid out in the guideline set down by the member states of the EEC Commission.

This declaration is valid for all samples that are part of this declaration, which are manufactured according to the production charts appendix.

The standards relevant for the evaluation of safety & EMC requirements are as follows :

1. Certificate of conformity / Test report issued by :
2. Technical documentation kept at :  
which will be made available upon request.

LVD : EN 60950:1992+A1+A2+A3+A4+A11, EN 60825-1:1994+A1
EMC : EN55022:1998incA1:2000, EN61000-3-2:2000,EN61000:3-3:1995incA1:2001 EN55024:1998incA1:2001, AS/NZS3548:1995,EN61000:4-2:1995, EN61000:4-1996, EN61000:4-4:1995, EN61000:4-5:1995 EN61000:4-6:1996, EN61000:4-11:1994

LVD : TUV Rheinland
EMC : SAMSUNG Electronics EMC Lab of digital R&D center in Suwon.

Samsung Electronics Co.,Ltd.
------------------------------

(Manufacturer)

Samsung Electronics Co.,Ltd. #259, Gongdan-Dong, Gumi-City Gyungbuk, Korea 730-030  2006-01-20	 Whan-Soon Yim / Senior Manager
(place and date of issue)	(name and signature of authorized person)

(Representative in the EU)

Samsung Electronics Euro QA Lab. Blackbushe Business Park, Saxony Way Yateley, Hampshire, GU46 6GG, UK  2006-01-20	 Yong-Sang Park / Manager
(place and date of issue)	(name and signature of authorized person)



# 1 Introduction

Congratulations on the purchase of your printer!

This chapter includes:

- **Special Features**
- **Printer Components**

## Special Features

Your new printer is equipped with several special features that improve the print quality. You can:

### Print in color with excellent quality and speed



- You can print in a full range of colors using cyan, magenta, yellow, and black.
- You can print up to 2400 x 600 dpi (effective output). For details, see the **Software Section**.
- Your printer prints A4-sized paper at 20 ppm and letter-sized paper at 21 ppm.

### Use multiple types of media easily

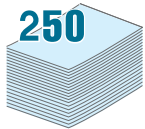

- The **Standard 250-sheet input tray** (Tray1) and **optional 500-sheet input tray** (Tray2) supports A4/letter-sized paper.
- The **Multi-purpose Tray** supports letterhead, envelopes, labels, custom-sized materials, postcards, and heavy paper. The **Multi-purpose Tray** also supports up to 100 sheets of plain paper.

### Create professional documents



- Print **Watermarks**. You can customize your documents with a watermark, such as the word "Confidential." For details, see the **Software Section**.
- Print **Booklets**. This feature enables you to easily print a document to create a book. Once printed, all you have to do is fold and staple the pages. For details, see the **Software Section**.
- Print **Posters**. The text and pictures of each page of your document can be magnified and printed across several sheets of paper and taped together to form a poster. For details, see the **Software Section**.

## Save time and money

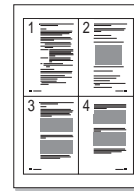

- You can print on both sides of the paper to save paper (**double-sided printing**). For details, see the **Software Section**.
- You can print multiple pages on a single sheet of paper to save paper.
- You can use preprinted forms and letterhead. For details, see the **Software Section**.
- This printer automatically **conserves electricity** by substantially reducing power consumption when not printing.

## Expand the printer capacity

- This printer has 256 MB of memory which can be expanded to 512 MB.
- You can install an optional 500-sheet tray in your printer. This tray reduces how often you have to add paper to the printer.

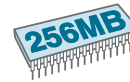

\* PostScript 3 Emulation



© Copyright 1995-2005, Zoran Corporation. All rights reserved. Zoran, the Zoran logo, IPS/PS3 and OneImage are trademarks of Zoran Corporation.

\* 136 PS3 fonts

Contains UFST and MicroType from Monotype Imaging Inc.

## Print in various environments



You can print in **Windows 98SE/Me/NT 4.0/2000/2003/XP**.

- Your printer is compatible with **Macintosh** and **various Linux OS**.
- Your printer comes with both the **USB** and **Parallel** interface.
- The CLP-650N comes with a built-in **Network interface**, 10/100 Base TX.

## Printer Features

The table below lists a general overview of features supported by your printer.

(S: Standard, O: Option N/A: Not available)

Features	CLP-650	CLP-650N
IEEE 1284 Parallel	S	S
USB 2.0	S	S
PostScript Emulation	S	S
Network Interface (Ethernet 10/100 Base TX)	N/A	S

# Printer Components

These are the main components of your printer. Note that all illustrations on this User's Guide are from the CLP-650N and that some parts may be different from your printer.

## Front View

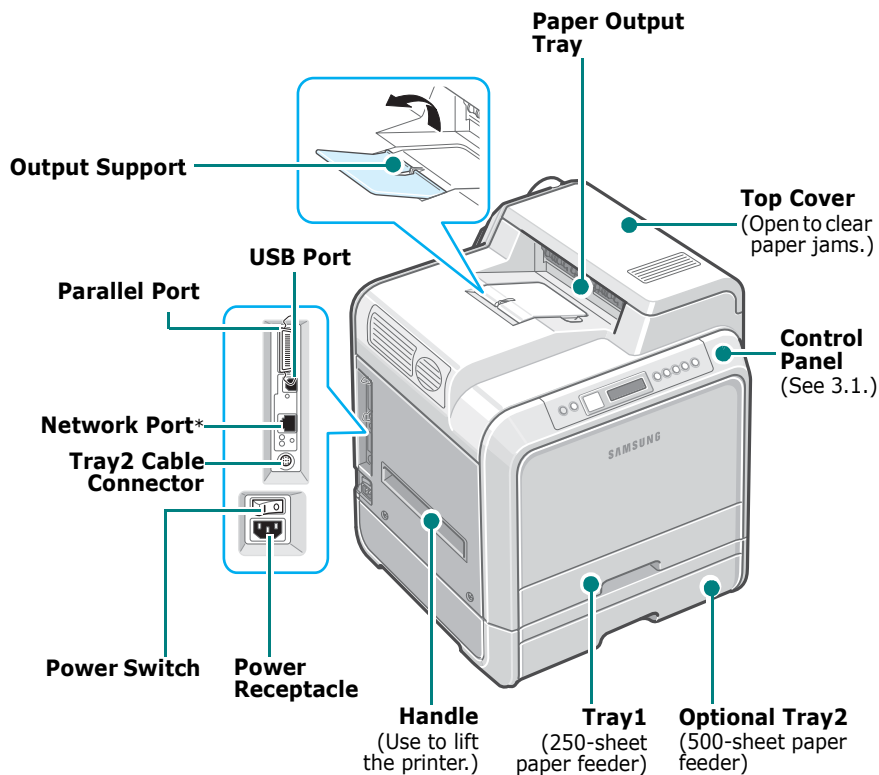

\* Only the CLP-650N comes with a network port.

**NOTE:** The surface of the output tray may become hot if you print a large number of pages at once. Please make sure that you don't touch the surface, and prevent children from approaching it.

## Right Side View

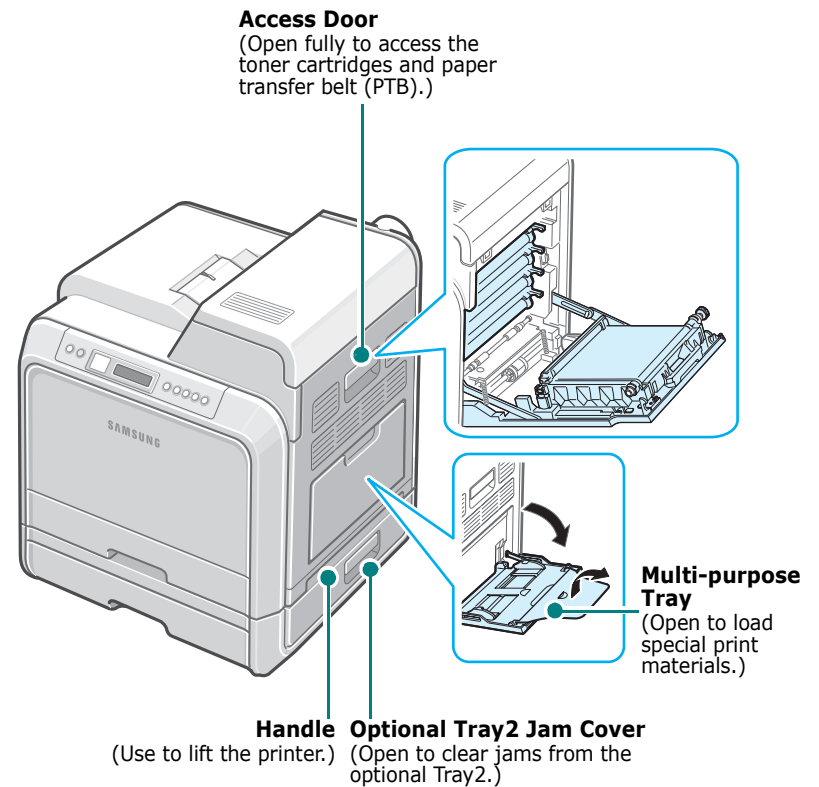

# 2 Setting Up Your Printer

This chapter gives you step-by-step instructions for setting up your printer.

This chapter includes:

- **Unpacking**
- **Installing the Toner Cartridges**
- **Loading Paper**
- **Connecting a Printer Cable**
- **Turning the Printer On**
- **Printing a Demo Page**
- **Changing the Display Language**
- **Installing the Printer Software**

## Unpacking

- 1 Remove the printer and all of the accessories from the packing carton. Make sure that the printer has been packed with the following items:



Toner Cartridges



Power Cord

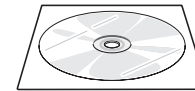

Printer software CD

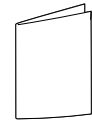

Quick Install Guide

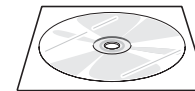

Network Utilities CD  
(CLP-650N only)

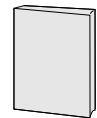

Network Printer Quick Guide  
(CLP-650N only)

### NOTES:

- If any items are missing or damaged, notify your dealer immediately.
- **Components may differ from one country to another.**
- The Printer software CD contains the printer driver, the User's Guide, and the Adobe Acrobat Reader program.
- The appearance of the power cord may differ depending on your country's specifications. The power cord must be plugged into a grounded power socket.



**CAUTION:** This printer weighs 29.1kg including the toner cartridges and the cassette. Use safe lifting and handling techniques. If you need to move the printer, it should be moved by two people. Use the lifting handles, as shown in the diagram (see page 1.3). Back injury could result if a single person attempts to lift the printer.

- 2 Carefully remove all of the packing tape from the printer.

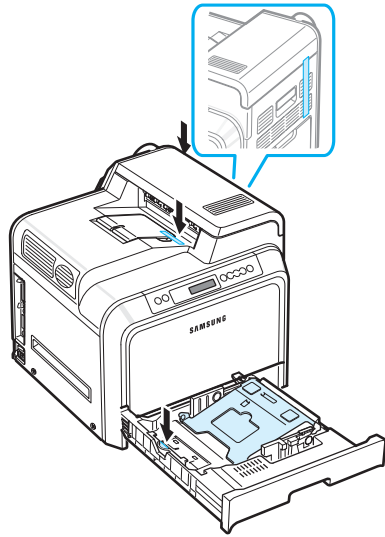

- 3 Pull the paper tray out of the printer and remove the packing tape from the tray.

- 4 Select a location for the printer:

- Leave enough room to open the printer trays and covers, and to allow for proper ventilation.
- Provide the proper environment:
  - A firm, level surface
  - Away from the direct airflow of air conditioners, heaters, or ventilators
  - Free of temperature, sunlight, and humidity extremes or fluctuations
  - Clean, dry, and free of dust

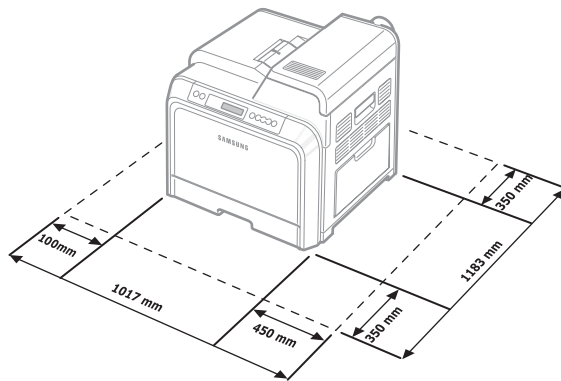

**CAUTION:** You must place your printer on a level surface. If you do not, print quality problems can occur.

## Installing the Toner Cartridges

- 1 Using the handle, completely open the access door.

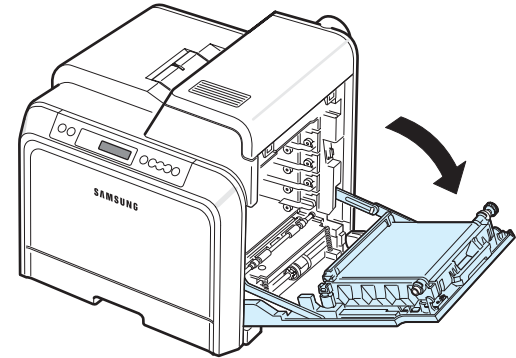

**NOTE:** The paper transfer belt is already installed in your printer.

- 2 Take the toner cartridges out of their packages.

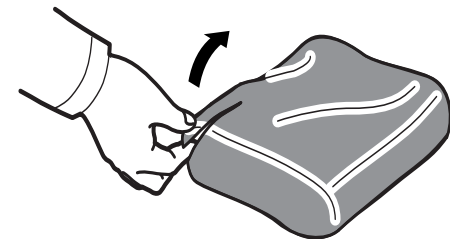
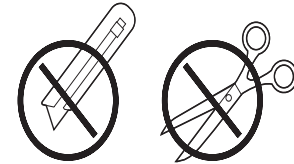

### CAUTION:

- Do not use sharp objects, such as a knife or scissors, to open the toner cartridge packages. You could damage the surface of the toner cartridges.
- To prevent damage, do not expose the toner cartridges to light for more than a few minutes. Cover them with paper to protect them if necessary.
- Do not touch the green surface, the OPC drum, on the front of each toner cartridge with your hands or any other material. Use the handle on each cartridge in order to avoid touching this area.

- 3** Holding both handles on the toner cartridges, gently rock them from side to side to evenly distribute the toner.

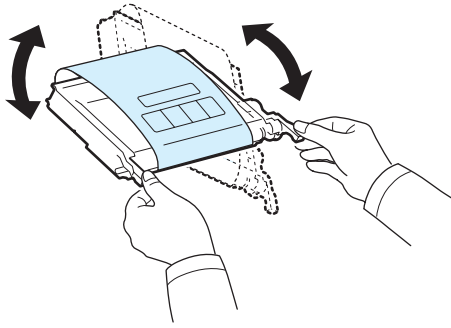

- 4** Place the toner cartridges on a flat surface, as shown, and remove the paper covering the toner cartridges by removing the tape.

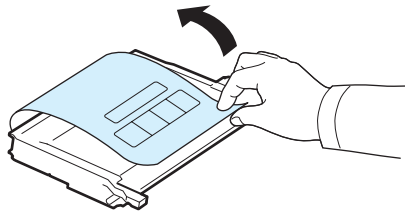

**NOTE:** If toner gets on your clothing, wipe it off with a dry cloth and wash it in cold water. Hot water sets toner into fabric.

- 5** On the inside right hand wall of the printer, a label identifies which color cartridge goes into each cartridge slot.

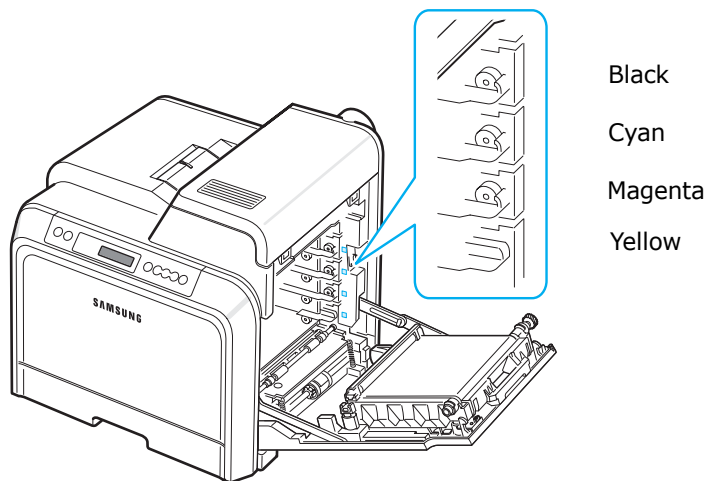

- 6** Grasp the handles on each toner cartridge. Align the toner cartridges with the slots inside the printer and insert them into their corresponding positions in the following order: Yellow, Magenta, Cyan, and then Black, until they click into place.

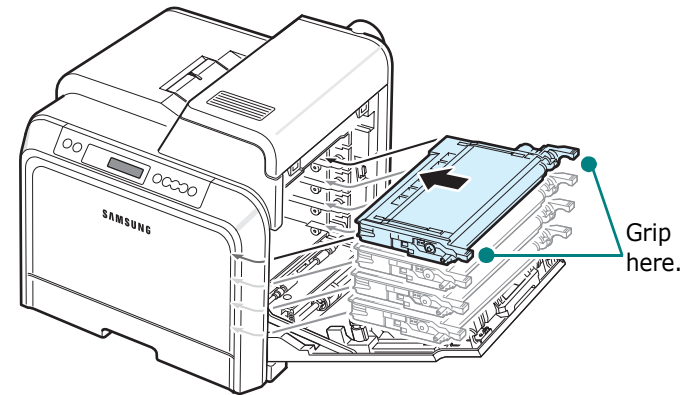

- 7** Close the access door. Make sure that the door is securely latched.

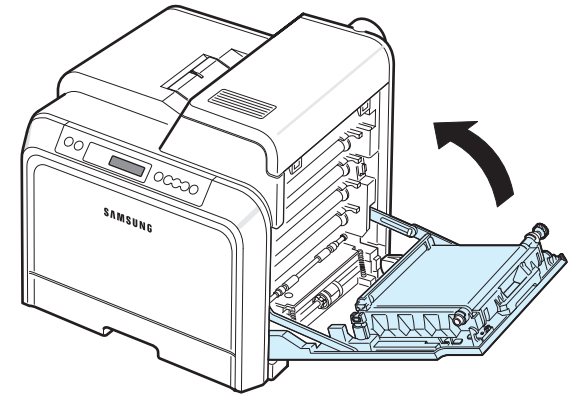

**CAUTION:** If the access door is not completely closed, the printer will not operate.

**NOTE:** When printing text at 5% coverage, you can expect a toner cartridge life of about 4,000 pages for black and color.

## Loading Paper

The tray (Tray1) can hold a maximum of 250 sheets of plain paper. You can use A4 and letter-sized paper.

To load paper:

- 1 Pull the tray out of the printer.

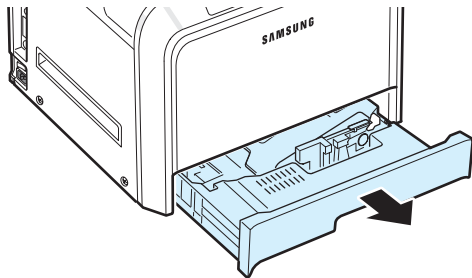

- 2 Push down on the metal plate until it locks into position.

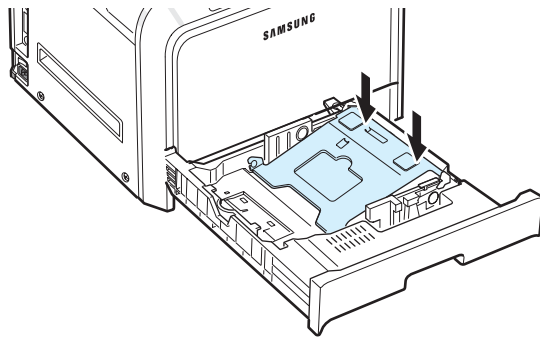

- 3 Flex the paper sheets back and forth to separate the pages and then fan them while holding one edge. Tap the edges of the stack on a flat surface to even it up.

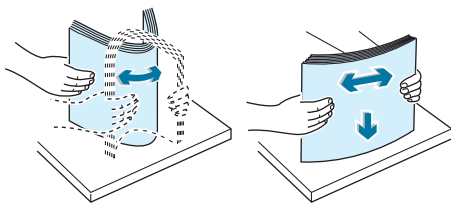

- 4 Load paper with the print side facing up.

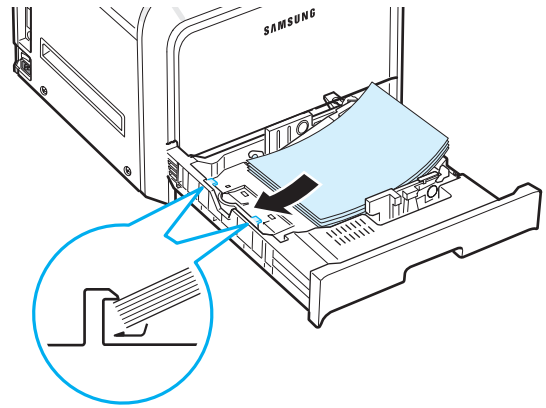

Make sure not to overfill the tray and that all four corners are flat in the tray and under the corner brackets, as shown below. Overfilling the tray may cause a paper jam.

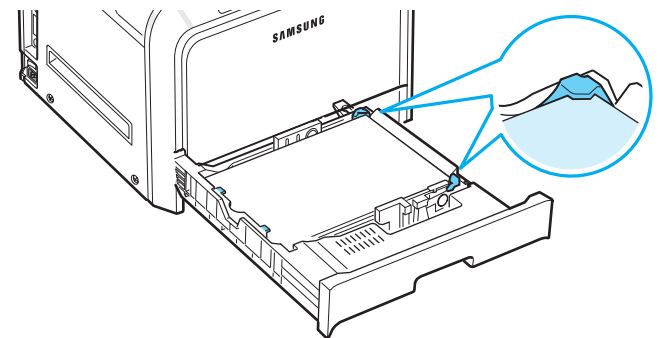

**NOTE:** If you want to change the size of the paper in the tray, refer to "Changing the Size of the Paper in the Tray" on page 2.5.

- 5 Slide the tray back into the printer.

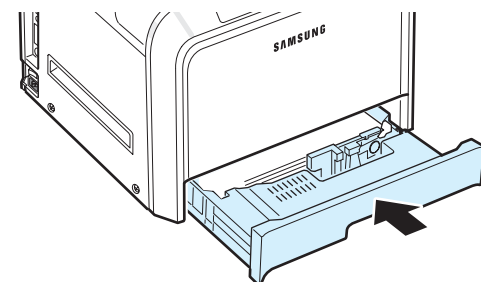

**NOTE:** After you load paper, you need to set up your printer for the paper type, size, and source you loaded. For details, see the **Software Section**.

## Changing the Size of the Paper in the Tray

The tray is preset to Letter or A4 size, depending on your country. To change the size to A4 or Letter, you must adjust the paper length guide properly.

- 1 Pull the tray open. After you pull it all the way out, lift up the front part of the tray slightly to release the tray from the printer. Remove paper from the tray.

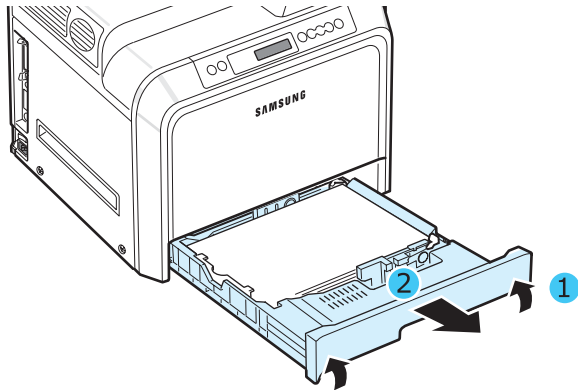

- 2 Push down on the metal plate until it locks into position.

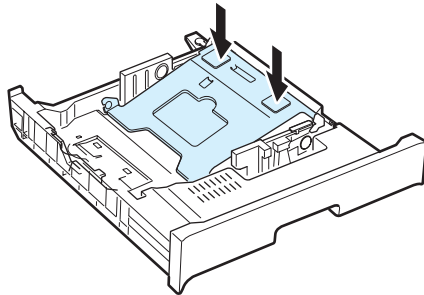

- 3 Lift the paper length guide and place it in the correct position for the paper size you are loading.

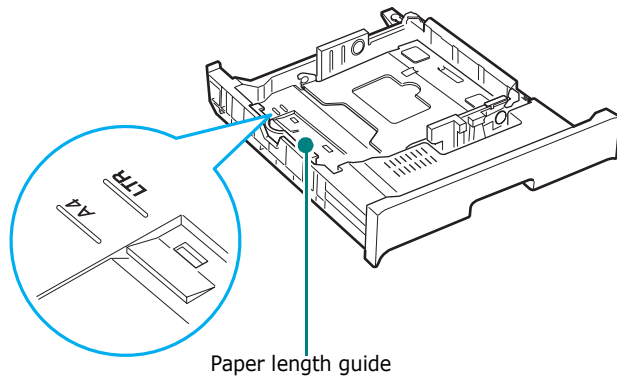

To remove the paper length guide, turn it slightly to your right to release the locks on the bottom of the guide, then pull it up.

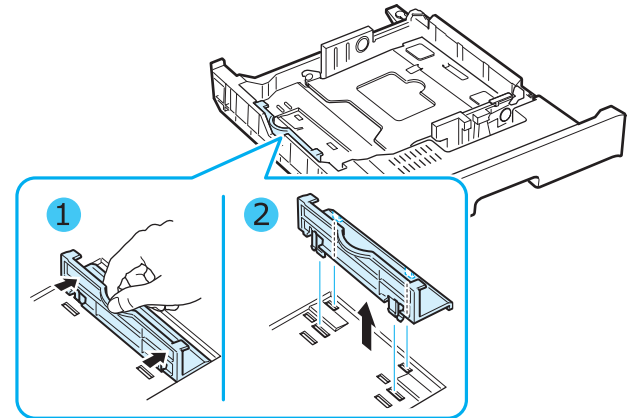

To place the paper length guide in the paper position you want, insert the locks on the bottom of the guide into the desired paper slot and push it all the way in.

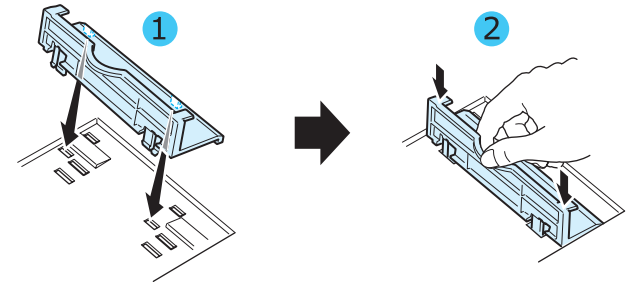

- 4 Holding the handle of the white stopper on the rear part of the tray, rotate the handle counter clockwise and remove it from the tray. After removing it, insert the stopper in the other hole and rotate it clockwise to lock it into position.

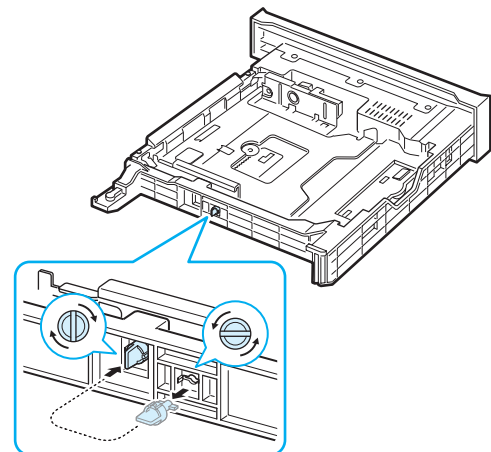



- 5** Squeeze the paper width guide, as shown and slide it to the stack of paper until it lightly touches the side of the stack. Do not push the guide too tightly against the edge of the paper as it may cause the paper to bend.

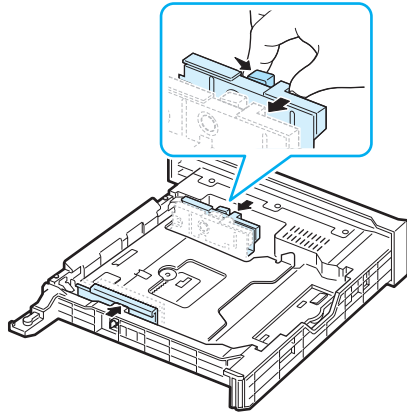

**NOTES:**

- Do not push the width guide far enough to cause the material to warp.
- If you do not correctly adjust the width guide, it may cause a paper jam.

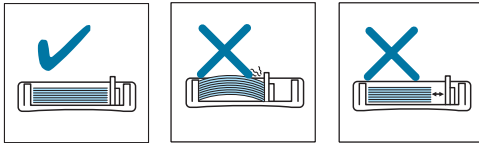

- 6** Load paper with the print side facing up. For more information, see steps 4 and 5 on page 2.4.

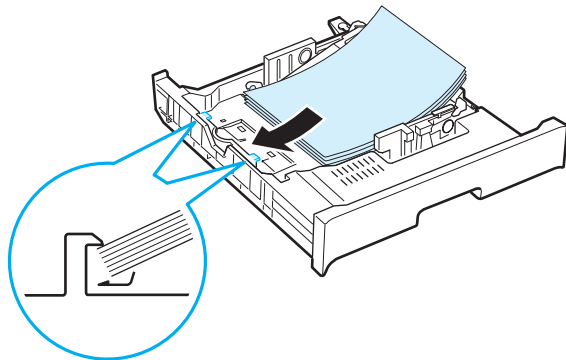

- 7** To replace the tray, lower the rear edge, align it with the slot, and slide it into the printer.

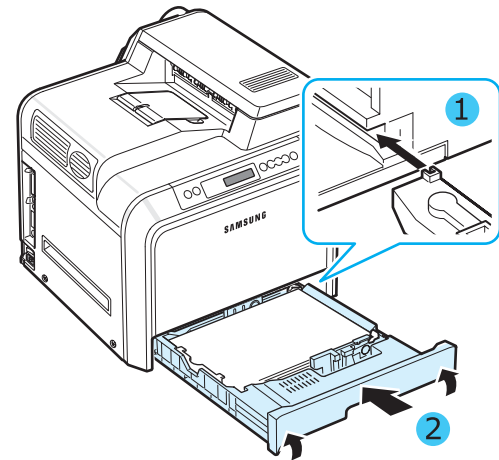

## Connecting a Printer Cable

### For Local Printing

To print from your computer in a local environment, you need to connect your printer to the computer with either a parallel interface cable or a Universal Serial Bus (USB) cable.

If you are a Macintosh user, you can use only a USB cable.

**NOTES:** You only need to connect one of cables mentioned above. Do not use the parallel and the USB cables at the same time.

### Using a USB Cable

**NOTES:**

- Connecting the printer to the USB port of the computer requires a certified USB cable. You will need to buy a USB 2.0 compliant cable that is 3m or less in length.
- To print using the USB interface, you must run Windows 98SE/Me/2000/2003/XP or Macintosh with OS 8.6 ~ 9.2/10.1 ~ 10.4.

- 1 Make sure that both the printer and the computer are turned off.
- 2 Plug the USB cable into the connector on the left rear of the printer.

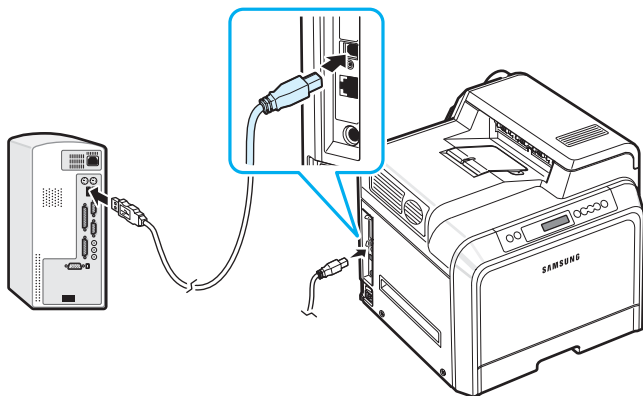

- 3 Connect the other end of the cable to the USB port on your computer.

### Using a Parallel Cable

**NOTES:** Connecting the printer to the parallel port of the computer requires a certified parallel cable. You will need to buy a IEEE1284 compliant cable that is 3m or less in length.

- 1 Make sure that both the printer and the computer are turned off.
- 2 Connect a parallel printer cable into the parallel port on the back of the printer.

Push the metal clips down to fit inside the notches on the cable plug.

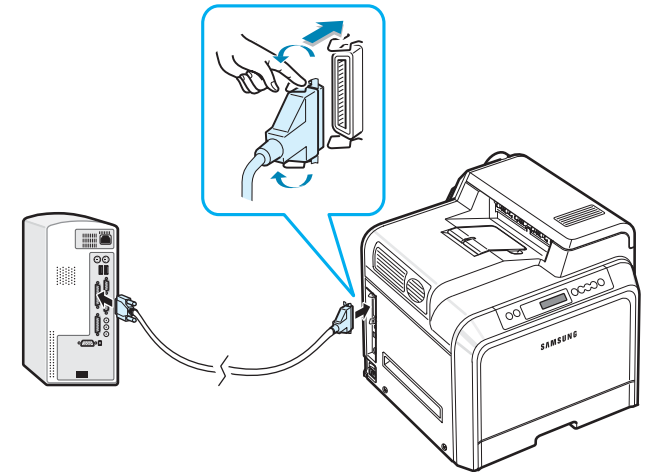

- 3 Connect the other end of the cable to the parallel interface port on your computer, and tighten the screws. See your computer's User's Guide, if you need help.

## For Network Printing (CLP-650N only)

You can attach your printer to a network using an Ethernet cable (UTP cable with RJ.45 connector).

The CLP-650N has a built-in network interface card.

### Using an Ethernet Cable

- 1 Make sure that both the printer and the computer are turned off.
- 2 Plug one end of the Ethernet cable into the Ethernet network port on the left rear of the printer.

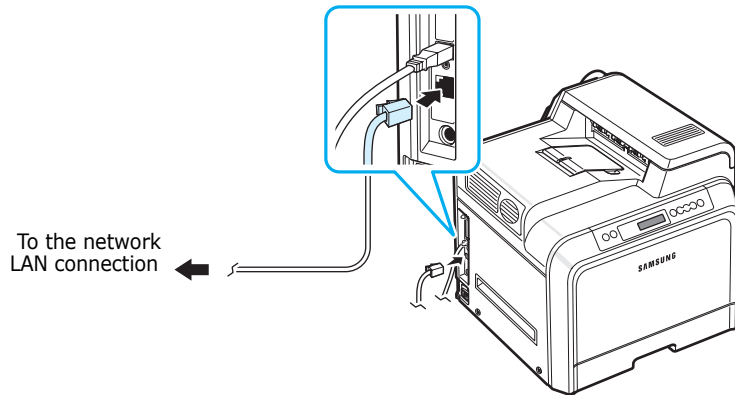

- 3 Plug the other end of the cable into a network LAN connection.

**NOTE:** After connecting the printer, you need to configure the network parameters on the control panel. See page 8.1. You can use the software supplied with the card. Refer to the Network Printer User's Guide.

## Turning the Printer On

- 1 Plug the power cord into the power receptacle on the left rear of the printer.
- 2 Plug the other end into a properly grounded AC outlet and turn on the power.

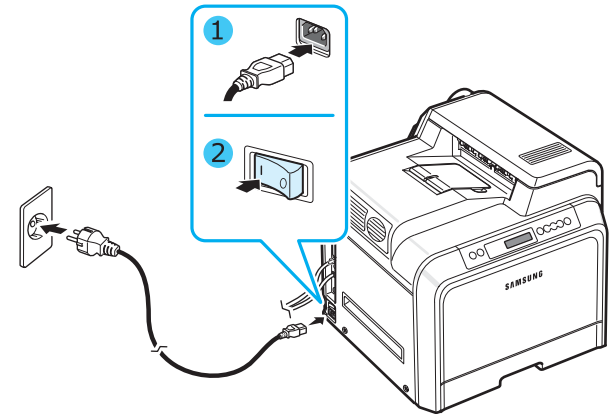

### CAUTION:

- Some parts inside of the printer may be hot when power is on, or after printing. Be careful not to burn yourself when working inside the printer.
- Do not disassemble the printer when it is turned on or plugged in. Doing so may give you an electric shock.

## Printing a Demo Page

Print a demo page to make sure that the printer is operating correctly.

To print a demo page:

In ready mode, press and hold the **On Line/Continue** button (  ) on the control panel for 2 seconds to print a demo page.

A demo page showing the printer's features and capabilities is printed.

## Changing the Display Language

To change the language that is displayed on the control panel, take the following steps:

- 1 In ready mode, press the **Menu** button (Ⓜ) on the control panel until you see "Setup" on the bottom line of the display.
- 2 Press the **Enter** button (Ⓜ) to access the menu.
- 3 Press the **Enter** button (Ⓜ) when "LCD Language" displays on the bottom line of the display.
- 4 Press the scroll button (⏪ or ⏩) until the language you want to use displays.
- 5 Press the **Enter** button (Ⓜ) to save the selection.
- 6 Press the **On Line/Continue** button (Ⓜ) to return to ready mode.

## Installing the Printer Software

*You must install software using the supplied Printer software CD after you have set up your printer and connected it to your computer. For details, see the **Software Section**.*

The Printer software CD provides you with the following software:

### Programs for Windows

You can install the following printer software using the Printer software CD.

- **Printer driver** for Windows. Use this driver to take full advantage of your printer's features. See the **Software Section** for details about installing the Samsung printer driver.
- **PostScript** Printer Description (PPD) file for Windows to allow installation of the PostScript driver. See the **Software Section** for detail about installing the PostScript driver.
- **SmartPanel**. Appears when printing errors occur. See the **Software Section** for details about installing the SmartPanel program.

### Macintosh Printer Driver

You can print from a Macintosh with your printer. Go to the **Software Section** for information about installing the print software and printing from a Macintosh.

## Linux Driver

You can print from a Linux-based computer with your printer. Go to the **Software Section** for information about installing the Linux driver and printing from a Linux environment.

## System Requirements

Before you begin, ensure that your system meets the minimum requirements. Your printer supports the following operating system.

- Windows 98SE/Me/NT 4.0/2000/XP/2003 - The following table shows Windows requirements.

Item	Requirements	
Operating system	Windows 98SE/Me/NT 4.0/2000/XP/2003	
RAM	98SE/Me	32 MB
	NT 4.0/2000	64 MB
	XP	128 MB
	2003	256 MB
Free Disk Space	98SE/Me/NT 4.0/2000/XP/2003	300 MB
Internet Explorer	5.0 or higher	

**NOTES:** For Windows NT 4.0/2000/XP/2003, the system administrator should install the software.

- Macintosh OS 8.6 ~ 9.2/10.1 ~ 10.4. - For details, see the **Software Section**.
- Various Linux OS - For details, see the **Software Section**.

## Printer Driver Features

Your printer drivers will support the following standard features:

- Paper source selection
- Paper size, orientation, and media type
- number of copies

The table below lists a general overview of features supported by your printer drivers.

Feature	Samsung proprietary Printer driver		
	Win98SE/Me/	NT 4.0/ 2000/XP/ 2003	Linux
Color Mode	Y	Y	N
Print Quality Option	Y	Y	Y
Poster Printing	Y	Y	N
Double-sided Printing	Y	Y	N
Multiple Pages Per Sheet (N-up)	Y	Y	Y
Fit to Page Printing	Y	Y	N
Scale Printing	Y	Y	N
Booklet Printing	Y	Y	N
Different Source For First Page	Y	Y	N
Watermark	Y	Y	N
Overlay*	Y	Y	N

\* The Overlay feature is not supported in NT 4.0

Feature	PostScript Printer Driver			
	Win98SE/ Me/	NT 4.0/ 2000/ XP/2003	Linux	Macintosh
Color Mode	Y	Y	Y	Y
Print Quality Option	Y	Y	Y	Y
Poster Printing	N	N	N	N
Double-sided Printing	Y	Y	N	N
Multiple Pages Per Sheet (N-up)	Y	Y	Y	Y
Fit to Page Printing	Y	Y	Y	Y
Scale Printing	Y	Y	Y	Y
Booklet Printing	N	Y	N	N
Different Source For First Page	N	N	Y	Y
Watermark	N	N	N	N
Overlay*	N	N	N	N

\* The Overlay feature is not supported in NT 4.0

**NOTE:** For details about installing software and using its features, see the **Software Section**.

# 3 Using the Control Panel

This chapter describes how to use the printer's control panel.

This chapter includes:

- **Understanding the Control Panel**
- **Using Control Panel Menus**

## Understanding the Control Panel

The control panel on the top right side of your printer has a display and seven buttons.

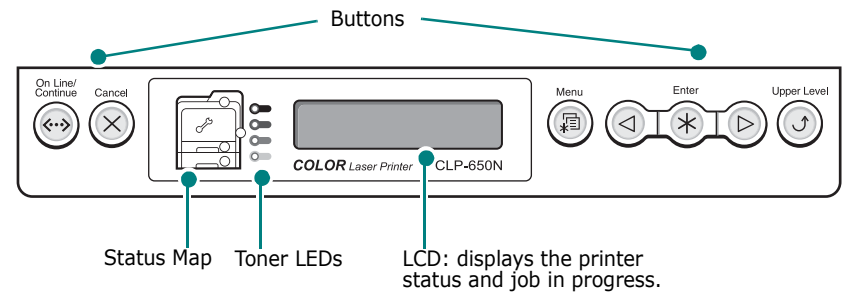











## Display

Message	Description
Ready	<ul style="list-style-type: none"><li>• The printer is on-line and ready to print.</li><li>• If you press the <b>On Line/Continue</b> button, the printer goes off-line.</li></ul>
Offline	<ul style="list-style-type: none"><li>• The printer is off-line and cannot print.</li><li>• If you press the <b>On Line/Continue</b> button, the printer switches on-line.</li></ul>
Processing...	<ul style="list-style-type: none"><li>• The printer is printing.</li><li>• If you want to stop printing, press the <b>Cancel</b> button.</li></ul>
Sleeping...	<ul style="list-style-type: none"><li>• The printer is in Power Save mode, using less power. When a print job is received from the computer, or if any button is pressed, the printer switches to on-line.</li><li>• To deactivate the Power Save mode or change the power-saving time, see page 3.6.</li></ul>

See "Understanding Display Messages" on page 7.14 for a complete listing of all printer messages.

## Buttons

Button	Description				
 (status map)	When a paper jam occurs, a lamp turns on at the corresponding location on the Status map so that you can locate the paper jam. The display on the control panel also shows the corresponding error message, indicating the location of the jam. For details on the meaning of the LEDs and error messages, see 7.4.				
 (toner LEDs) *If paper transfer belt is not installed in the printer, toner LEDs do not indicate the toner cartridge status.	<table border="1"> <tr> <td>On</td> <td>                             When a toner cartridge is empty, a corresponding lamp, indicating the color of the toner cartridge, turns on. Replace the corresponding toner cartridge with a new one. See page 6.4.                               Or, if you have installed an invalid toner cartridge, a corresponding lamp turns on. Install only Samsung toner cartridges, designed for your printer.                               Otherwise, if you have installed the toner cartridge into improper cartirdge slot, a corresponding lamp turns on. Install the toner cartridge into each proper cartridge slot.                         </td> </tr> <tr> <td>Blinking</td> <td>                             When a toner cartridge is low, a corresponding lamp, indicating the color of the toner cartridge, blinking. Order a new toner cartridge. You can Temporarily improve print quality by redistributing the toner. See page 6.2                         </td> </tr> </table>	On	When a toner cartridge is empty, a corresponding lamp, indicating the color of the toner cartridge, turns on. Replace the corresponding toner cartridge with a new one. See page 6.4.  Or, if you have installed an invalid toner cartridge, a corresponding lamp turns on. Install only Samsung toner cartridges, designed for your printer.  Otherwise, if you have installed the toner cartridge into improper cartirdge slot, a corresponding lamp turns on. Install the toner cartridge into each proper cartridge slot.	Blinking	When a toner cartridge is low, a corresponding lamp, indicating the color of the toner cartridge, blinking. Order a new toner cartridge. You can Temporarily improve print quality by redistributing the toner. See page 6.2
On	When a toner cartridge is empty, a corresponding lamp, indicating the color of the toner cartridge, turns on. Replace the corresponding toner cartridge with a new one. See page 6.4.  Or, if you have installed an invalid toner cartridge, a corresponding lamp turns on. Install only Samsung toner cartridges, designed for your printer.  Otherwise, if you have installed the toner cartridge into improper cartirdge slot, a corresponding lamp turns on. Install the toner cartridge into each proper cartridge slot.				
Blinking	When a toner cartridge is low, a corresponding lamp, indicating the color of the toner cartridge, blinking. Order a new toner cartridge. You can Temporarily improve print quality by redistributing the toner. See page 6.2				
	<ul style="list-style-type: none"> <li>Press to enter menu mode.</li> <li>In menu mode, press to scroll through the menus.</li> </ul>				
	In menu mode, press to select the displayed sub menu item or to confirm the changed setting. The selected item is marked with an *.				
	In menu mode, press to scroll through sub menu items or setting options. Pressing  moves you to the next option and pressing  sends you back to the previous option.				
	<ul style="list-style-type: none"> <li>Press to cancel the current print job.</li> <li>In menu mode, press to return to ready mode.</li> </ul>				
	In menu mode, press to go back to the upper menu level.				

Button	Description		
 On Line/Continue	<ul style="list-style-type: none"> <li>Press to switch between on-line and off-line.</li> <li>In menu mode, press to return to ready mode.</li> </ul> The color of the <b>On Line/Continue</b> button indicates the status of the printer.		
	Green	On	The printer is on-line and can receive data from the computer.
		Blinking	<ul style="list-style-type: none"> <li>When the light blinks slowly, the printer is receiving data from the computer.</li> <li>When the light blinks quickly, the printer is receiving and printing data.</li> </ul>
	Red	On	Check the display message or SmartPanel. See page 7.14 for details on the meaning of the error message.
		Blinking	A minor error has occurred and the printer is waiting for the error to be cleared. Check the display message or SmartPanel. When the problem is cleared, the printer resumes printing. If you want to ignore this warning, press this button.
Off	<ul style="list-style-type: none"> <li>The printer is off-line and cannot print.</li> <li>The printer is in Power Save mode. When data is received, it switches to on-line automatically.</li> </ul>		

## Using Control Panel Menus

A number of menus are available to make it easy for you to change printer settings. The diagram on page 3.3 shows the menus and all of the items available in each menu. The items in each menu and the options you can select are described in more detail in the tables beginning on page 3.4.

## Accessing Control Panel Menus

You can configure your printer from the printer's control panel.

- 1 In ready mode, press the **Menu** button (☰) until you see the menu you want on the bottom line of the display.
- 2 Press the **Enter** button (⊗) to access the menu.
- 3 Press the scroll button (◀ or ▶) until the menu item you want displays on the bottom line.
- 4 Press the **Enter** button (⊗) to confirm the selected item.
- 5 If the menu item has sub menus, repeat steps 3 and 4.
- 6 Press the scroll button (◀ or ▶) until the menu item you want displays on the bottom line.
- 7 Press the **Enter** button (⊗) to save your input or selection.  
An asterisk (\*) appears next to the selection on the display, indicating that it is now the default.
- 8 To exit the menu, press the **Upper Level** button (☺) repeatedly, or the **Cancel** button (⊗).

After 60 seconds of inactivity (no key being pressed), the printer automatically returns to ready mode.

**NOTE:** Print settings made from the printer driver on a connected computer override the settings on the control panel.

## Overview of Control Panel Menus

The control panel menus are used to configure the printer. The control panel provides access to the following menus:

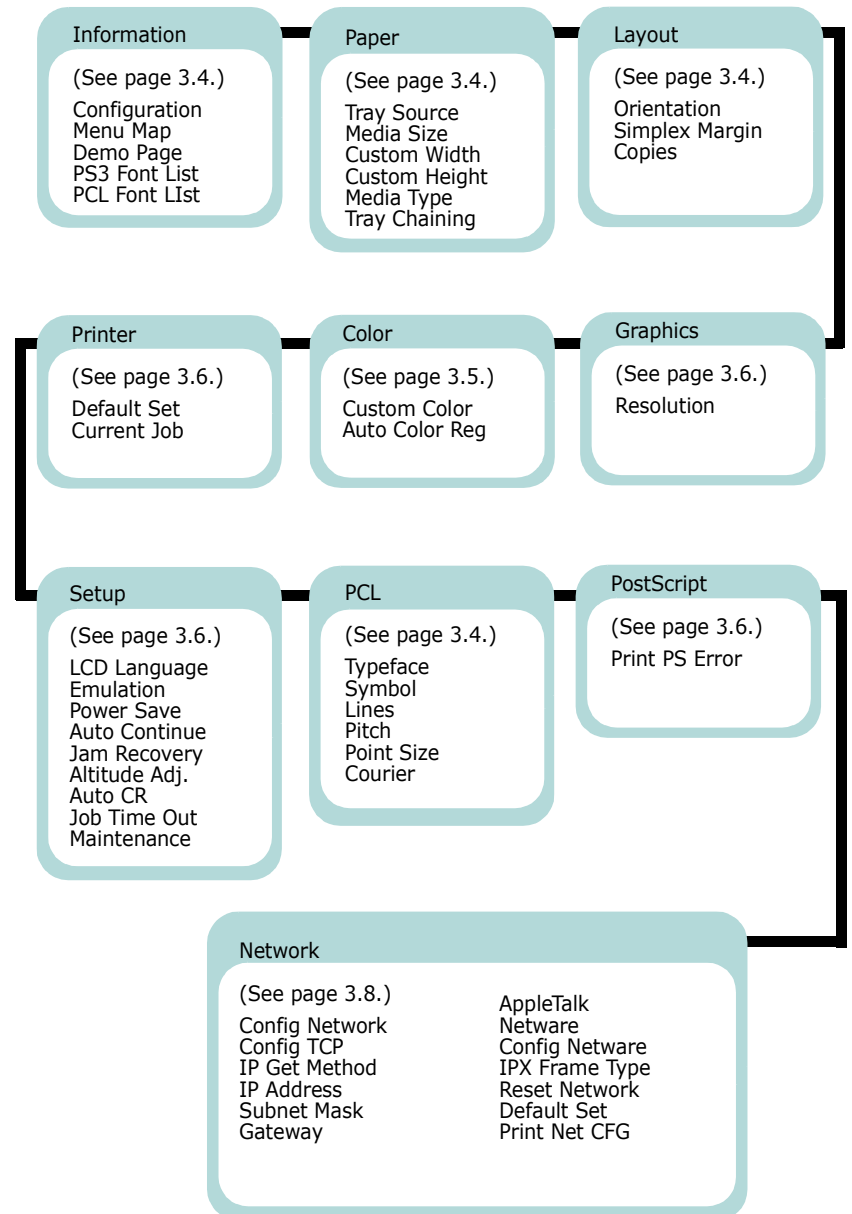



## Information Menu

This menu contains information pages that you can print to give details about the printer and its configuration.

Item	Explanation
Configuration	The configuration page shows the printer's current configuration. See page 6.1.
Menu Map	The menu map shows the layout and current settings of the control panel menu items.
Demo Page	The demo page allows you to check to see if your printer is printing properly.
PS3 Font List PCL Font List	The font sample list shows all of the fonts currently available in the selected language.

## Paper Menu

Use this menu to define all settings relating to print material input and output, as well as the specific print material you are using with your printer.

(\*: the default setting)



Item	Explanation
Tray Source	<p>Values: Auto Select, Tray 1, MP Tray, Tray 2, Manual Tray</p> <p>Using this item, you can set the tray you will use.</p> <ul style="list-style-type: none"> <li>If you select <b>Auto Select</b>, the printer can automatically determine the source.</li> <li>Select <b>MP Tray</b> or <b>Manual Tray</b> to use the Multi-purpose Tray. If you select <b>Manual Tray</b>, you need to press the <b>On Line/Continue</b> button each time you print a page.</li> <li>The <b>Tray 2</b> item is available only when the optional Tray2 is installed.</li> </ul>
Media Size	<p>Values: Letter, Legal, A4, Executive, JIS B5, ISO B5, No.10 Env., Monarch Env., DL Env., C5 Env., C6 Env., US Folio, A5, A6, Custom, Oficio, 6 3/4 Env., No.9 Env. * Letter for USA, A4 for Europe and Asia</p> <p>Select the paper size currently loaded in the tray.</p>

Item	Explanation
Custom Width	<p>Values: 90 mm ~, 210 mm (A4), 215 mm (Letter), 216 mm * Letter for USA, A4 for Europe and Asia</p> <p>Select the paper size currently loaded in the tray. This Menu is shown when the <b>Media Size</b> value is set up by <b>Custom Size</b>.</p> <ul style="list-style-type: none"> <li><b>Custom Width:</b> Set the custom width, from 90 to 216 mm</li> </ul>
Custom Height	<p>Values: 140 mm ~, 279 mm (Letter), 297 mm (A4), 356 mm * Letter for USA, A4 for Europe and Asia</p> <p>Select the paper size currently loaded in the tray. This Menu is shown when the <b>Media Size</b> value is set up by <b>Custom Size</b>.</p> <p><b>Custom Height:</b> Set the custom height, from 140 to 356 mm</p>
Media Type	<p>Values: Off, Plain Paper, Thick, Thin, Bond, Color Paper, Card Stock, Labels, Envelope, Preprinted, Cotton, Recycled</p> <p>The Media Type setting lets you specify the type of print material you are using to get the best result.</p> <ul style="list-style-type: none"> <li><b>Plain Paper:</b> Select for plain paper.</li> <li><b>Thick:</b> Select for thick paper</li> <li><b>Thin:</b> Select for thin paper</li> <li><b>Bond:</b> Select for thick paper.</li> <li><b>Color Paper:</b> Select for colored paper.</li> <li><b>Card Stock:</b> Select for card stocks.</li> <li><b>Labels:</b> Select for labels.</li> <li><b>Envelope:</b> Select for envelopes.</li> <li><b>Preprinted:</b> Preprinted is for paper with something else printed on it, such as letterhead.</li> <li><b>Cotton:</b> Select for cotton paper, such as Gilbert 25% and Gilbert 100%.</li> <li><b>Recycled:</b> Select for Recycled paper.</li> </ul>
Tray Chaining	<p>Values: Off, On</p> <p>When you select any other value except <b>Auto Select</b> from <b>Tray Source</b> and the selected tray is empty, the printer automatically prints from other trays.</p> <p>If this menu item is set to <b>Off</b>, the <b>On Line/Continue</b> button backlight blinks in orange and the printer doesn't work until you insert paper into the specified tray.</p>

## Layout Menu

Use the **Layout** menu to define all settings relating to output.

(\*: the default setting)

Item	Explanation
Orientation	<p>Values: Portrait, Landscape</p> <p>Choose the default orientation of print image on the page.</p> <div style="display: flex; justify-content: space-around; align-items: center;"> <div style="text-align: center;">  <p>Portrait</p> </div> <div style="text-align: center;">  <p>Landscape</p> </div> </div>
Simplex Margin	<p>Values: 0.0" (0 mm)</p> <p>Set the margin of print materials for one-sided printing. You can increase or decrease the value in 0.1 increments.</p> <ul style="list-style-type: none"> <li>• <b>Top Margin:</b> Set the top margin, from 0.0" (0 mm) to 9.9" (250 mm).</li> <li>• <b>Left Margin:</b> Set the left margin, from 0.0" (0 mm) to 6.8" (164 mm).</li> </ul>
Copies	<p>Values: 1 ~ 999</p> <p>Set the default number of copies by selecting any number from 1 to 999.</p>

## Graphics Menu

Use the **Graphics** menu to change settings affecting the quality of the printed characters and images.

(\*: the default setting)

Item	Explanation
Resolution	<p>Values: 600dpi-Normal, 1200dpi-Best</p> <p>Specify the number of dots printed per inch (dpi). The higher the setting, the sharper the clarity of printed characters and graphics.</p> <ul style="list-style-type: none"> <li>• If your print jobs are mostly text, select <b>600dpi-Normal</b> for the highest quality output.</li> <li>• Select <b>1200dpi-Best</b> when your job contains bitmapped images, such as scanned photos or certain business graphics, that will benefit from enhanced line screening.</li> </ul>

## Color Menu

This menu allows you to adjust the color setting.

(\*: the default setting)

Item	Explanation
Custom Color	<p>This item allows you to adjust contrast, color by color.</p> <p><b>CMYK:</b> Allows you to adjust the contrast of the toner in each toner cartridge.</p> <ul style="list-style-type: none"> <li>• <b>Default:</b> Optimizes colors automatically.</li> <li>• <b>Manual Adjust:</b> Allows you to manually adjust the color contrast for each cartridge.</li> </ul> <hr/> <p><b>NOTE:</b> You should use the <b>Default</b> setting for best color quality.</p>
Auto Color Reg <sup>*</sup>	<p>This menu item allows you to adjust the position of color texts or graphics to match the position of the printed colors to those on your screen.</p> <p><b>Run Now:</b> The printer executes the auto color registration now.</p>

\* Please operate **Auto Color Reg** manually after moving your printer.

## Printer Menu

This menu allows you to reset the printer settings or cancel the current job.

Item	Explanation
Default Set	This menu item allows you to restore the printer's factory default settings.
Current Job	You can cancel the current print job and remove it from the printer buffer.

## Setup Menu

Use the **Setup** menu to configure a variety of printer features.

(\*: the default setting)

Item	Explanation
LCD Language	<p>Options: English, Czech, Danish, Dutch, Finnish, French, German, Hungarian, Italian, Norwegian, Polish, Portuguese, Russian, Spanish, Swedish, Turkish</p> <p>The LCD Language setting determines the language of the text that appears on the control panel display and information printing.</p>
Emulation	<p>Values: Auto, PCL, HEXDUMP, PS3</p> <p>The printer language defines how the computer communicates with the printer. If you select <b>Auto</b>, your printer can change the printer language automatically.</p>
Power Save	<p>Options: 5 Minutes, 10 Minutes, 15 Minutes, 30 Minutes, 45 Minutes, 60 Minutes, 120 Minutes</p> <p>When the printer does not receive data for an extended period of time, power consumption is automatically lowered. You can set how long the printer waits before going to power save.</p>

Item	Explanation				
Auto Continue	<p>Options: Off, On</p> <p>This item determines whether or not the printer continues printing when it detects paper not matched to your paper setting.</p> <ul style="list-style-type: none"> <li>• <b>Off</b>: If a paper mismatch occurs, the message remains on the display and the printer remains off-line until you insert the correct paper.</li> <li>• <b>On</b>: If the paper is mismatched, an error message displays. The printer goes off-line for 30 seconds then automatically clears the message and continues printing.</li> </ul>				
Jam Recovery	<p>Options: Off, On</p> <p>This item determines how the printer behaves when a paper jam occurs.</p> <ul style="list-style-type: none"> <li>• <b>Off</b>: The printer does not reprint pages. Printing performance might be increased with this setting.</li> <li>• <b>On</b>: The printer automatically reprints pages after you clear the paper jam.</li> </ul>				
Altitude Adj.	<p>Options: Plain, High, Higher, Highest</p> <p>You can optimize the print quality according to your altitude.</p>				
Auto CR	<p>Values: LF, LF+CR</p> <p>This item allows you to append the required carriage return to each line feed.</p> <p>Refer to the following samples:</p> <table style="width: 100%; border: none;"> <tr> <td style="border: 1px solid black; padding: 5px; text-align: center;">           AA BB CC         </td> <td style="border: 1px solid black; padding: 5px; text-align: center;">           AA BB CC         </td> </tr> <tr> <td style="text-align: center;">LF</td> <td style="text-align: center;">LF+CR</td> </tr> </table>	AA BB CC	AA BB CC	LF	LF+CR
AA BB CC	AA BB CC				
LF	LF+CR				
Job Time Out	<p>Values: 0 ~ 1800 sec</p> <p>You can set the length of time the printer waits before printing the last page of a print job that does not end with a command to print the page.</p> <p>When a print time-out occurs, the printer prints the page in the print buffer.</p>				

Item	Explanation
Maintenance	<p>This item allows you to maintain the toner cartridges and other consumables.</p> <ul style="list-style-type: none"> <li>• <b>Check Others:</b> This item allows you to view the usage status of consumables.  <b>Items you can check:</b> <ul style="list-style-type: none"> <li>- <b>Fuser</b></li> <li>- <b>MP Pickroll, Tray1 Pickroll, Tray2 Pickroll:</b> These items are only for service technicians.</li> </ul> </li> <li>• <b>Alarm Shortage:</b> This item determines how the printer behaves when consumable items run low.  <b>Off:</b> The printer does not display a warning message.  <b>On:</b> The printer displays a warning message.</li> </ul>

## PCL Menu

This menu sets the PCL emulation configuration. You can set the font type, symbol type, lines per page, and point size.

(\*: the default setting)

Item	Explanation
Typeface	<p>Values: PCL1 ~ PCL54</p> <p>You can select the standard font to be used in PCL emulation.</p> <ul style="list-style-type: none"> <li>• PCL1~PCL7's interval between letters is fixed, and PCL8~PCL44's interval is proportional to the font type and point size. You can adjust the font size of PCL1~PCL7 using the <b>Pitch</b> item, and PCL8~PCL44 can do using <b>Point Size</b> item.</li> </ul> <p>PCL45~PCL54's interval and point size are fixed.</p>
Symbol	<p>Values: PC8 ~ PC1004</p> <p>This item selects the symbol to be used in PCL emulation. The symbol is the group of numbers, marks, and special signs being used when printing letters.</p>

Item	Explanation
Lines	<p>Values: 5 ~ 128</p> <p>This item allows you to set vertical spacing from 5 to 128 lines for the default paper size. The default value of Lines may differ according to the paper size and printing orientation.</p>
Pitch	<p>Values: 0.44 ~ 99.99 (0.01 unit)</p> <p>When you select from PCL1 to PCL7 from the <b>Typeface</b> menu, you can determine the font size by setting the number of characters that will print in one horizontal inch of type. The default value, 10, is the recommended size.</p>
Point Size	<p>Values: 4.00 ~ 999.75 (0.25 unit)</p> <p>When you select from PCL8 to PCL44 from the <b>Typeface</b> menu, you can determine the font size by setting the height of the font characters.</p>
Courier	<p>Values: Regular, Dark</p> <p>This item lets you select the version of Courier font to use.</p>

## PostScript Menu

This menu provides you with the Print PS Error menu item.

(\*: the default setting)

Item	Explanation
Print PS Error	<p>Values: Off, On</p> <p>You can select whether or not your printer prints an error list when a PS error occurs.</p> <ul style="list-style-type: none"> <li>• Select <b>On</b> to print PS 3 emulation errors. If an error occurs, the job stops processing, the error message prints, and the printer flushes the job.</li> <li>• If this menu is set to <b>Off</b>, the job is flushed without an indication of the error.</li> </ul>

## Network Menu (CLP-650N only)

This menu lets you configure the network interface card installed in your printer according to how the network is set up. You can upgrade the network interface card firmware, and print the configuration. (\*: the default setting)

Item	Explanation
Config Network	Options: Yes, No Sets whether or not you configure the network. If you select Yes, you can configure the TCP/IP, Netware and AppleTalk menus.
Config TCP	Options: Yes, No Select whether you set the IP address or not. If you select <b>Yes</b> , you can configure the IP address. If you select <b>Yes</b> , the <b>IP Get Method</b> option appears on the display. You can select how to get the IP address.
IP Get Method	Options: Static, BOOTP, DHCP You can set this item only when you set the <b>Config TCP to Yes</b> . <ul style="list-style-type: none"> <li>• <b>Static</b>: You can enter an IP address, subnetmask, and gateway manually.</li> <li>• <b>BOOTP</b>: The BOOTP server allots an IP address to you automatically.</li> <li>• <b>DHCP</b>: The DHCP server allots an IP address to you automatically.</li> </ul>
IP Address	You can select this item only when you set <b>IP Get Method to Static</b> . This item lets you enter an IP address manually. Press the scroll button to set the value of the 1st byte between 0 and 255, and then press the <b>Enter</b> button. Set the value for the 2nd, 3rd, and 4th byte the same way.
Subnet Mask	You can set this item only when you set <b>IP Get Method to Static</b> . This item lets you enter a subnet mask manually. Press the scroll button to set the value of the 1st byte between 0 and 255, and then press the <b>Enter</b> button. Set the value for the 2nd, 3rd, and 4th byte the same way.

Item	Explanation
Gateway	You can set this item only when you set <b>IP Get Method to Static</b> . This item lets you enter a gateway manually. Press the scroll button to set the value of the 1st byte between 0 and 255, and then press the <b>Enter</b> button. Set the value for the 2nd, 3rd, and 4th byte the same way.
AppleTalk	Options: On, Off You can select whether or not to use the AppleTalk for Macintosh. If you select On, you can use the AppleTalk.
Netware	Options: On, Off You can select whether or not to use the Netware protocol. If you select <b>On</b> , you can access the Config Netware menu item. In the <b>Config Netware</b> menu, you can specify the frame type parameter used on your network.
Config Netware	Options: Yes, No You can set this item only when you set <b>Netware to On</b> . This item lets you select whether or not you set the frame type parameter. Select <b>Yes</b> to select the frame type. If you select <b>Yes</b> , the <b>IPX Frame Type</b> option appears on the display.
IPX Frame Type	Values: Auto, EN_8022, EN_8023, EN_II, EN_SNAP You can select this item only when you set <b>Config Netware to Yes</b> . This item lets you select the IPX Frame Type. <ul style="list-style-type: none"> <li>• <b>Auto</b>: You can set a frame type automatically.</li> <li>• <b>EN_8022</b>: Select this value to use the IEEE 802.2 frame type.</li> <li>• <b>EN_8023</b>: Select this value to use the IEEE 802.3 frame type.</li> <li>• <b>EN_II</b>: Select this value to use the ETHERNET II frame type.</li> <li>• <b>EN_SNAP</b>: Select this value to use the SNAP frame type.</li> </ul>
Reset Network	This item reboots the network interface card.
Default Set	This item performs a simple reset and restores the factory default settings for the network configuration.

Item	Explanation
Print Net CFG	This item prints a page showing the network parameters you have set.

# 4 Using Print Materials

This chapter will help you understand the types of paper you can use with your printer and how to properly load paper in the different paper trays for the best print quality.

This chapter includes:

- **Choosing Paper and Other Materials**
- **Loading Paper**
- **Printing on Special Print Materials**

## Choosing Paper and Other Materials

You can print on a variety of print materials, such as plain paper, envelopes, labels, card stock, and so on. See “Printing on Special Print Materials” on page 4.4. To get the best possible print quality, use only high-quality, copier-grade paper.

When you choose print materials, consider the following:

- **Desired outcome:** The paper you choose should be appropriate for the project.
- **Size:** You can use any size paper that fits easily within the paper adjusters of the paper tray.
- **Weight:** Your printer supports paper weights as follows:
  - 20~24lbs (75~90g/m<sup>2</sup>) bond for Tray1 or optional Tray2
  - 20~43lbs (75~163g/m<sup>2</sup>) bond for the Multi-purpose Tray
- **Brightness:** Some papers are whiter than others and produce sharper, more vibrant images.
- **Surface smoothness:** The smoothness of the paper affects how crisp the printing looks on the paper.



**CAUTION:** Using a material that does not conform to the specifications listed on page 10.3 can cause problems that may require service. This service will not be covered by the warranty or service agreements.

## Sizes and Capacities

Size	Input Source/Capacity*			
	Tray1	Tray2 (option)	Multi-purpose Tray	
			Automatic Feed	Manual Feed
<b>Plain Paper</b>	250	500	100	1
<b>Envelopes**</b>	—	—	10	1
<b>Labels**</b>	—	—	10	1
<b>Card stock**</b>	—	—	10	1

\* Depending on paper thickness, maximum capacity may be reduced.

\*\* If you are experiencing excessive jamming, feed one sheet at a time through the Multi-purpose Tray.



**CAUTION:** This printer does not support transparencies.

## Guidelines for Paper and Special Materials

When selecting or loading paper, envelopes, or other special materials, keep these guidelines in mind:

- Attempting to print on damp, curled, wrinkled, or torn paper can cause paper jams and poor print quality.
- Use cut-sheet paper only. You cannot use multi-part paper.
- Use only high-quality, copier grade paper for the best print quality.
- Do not use paper with irregularities, such as tabs or staples.
- Do not attempt to load any tray while printing, and never overfill the tray. This could cause a paper jam.
- Avoid paper with embossed lettering, perforations, or a texture that is too smooth or too rough.
- Colored paper should be of the same high quality as white photocopy paper. The pigments must be able to withstand the printer's fusing temperature of 180°C (356°F) for 0.1 seconds without deteriorating. Do not use paper with a colored coating that was added after the paper was produced.
- Preprinted forms must be printed with nonflammable, heat-resistant ink that does not melt, vaporize, or release hazardous emissions when subjected to the printer's fusing temperature.
- Store paper in its ream wrapper until you are ready to use it. Place cartons on pallets or shelves, not on the floor.
- Do not place heavy objects on top of the paper, whether it is packaged or unpackaged.
- Keep paper away from moisture, direct sunlight, or other conditions that can cause it to wrinkle or curl.

**NOTE:** Do not use carbonless paper or tracing paper. These types of paper are unstable at the fusing temperature and can give off fumes, or cause damage to the printer.

## Loading Paper

Proper paper loading helps prevent paper jams and ensures trouble-free printing. Do not remove the paper tray while a job is printing. Doing so may cause a paper jam. See "Sizes and Capacities" on page 4.1 for acceptable paper capacities for each tray.



**CAUTION:** This printer does not support transparencies.

## Using Tray1

Load the print material you use for the majority of your print jobs in Tray1.

Tray1 can hold a maximum of 250 sheets of plain A4 or letter-sized paper.

You can purchase an optional tray, Tray2, and attach it below Tray1, to load an additional 500 sheets of paper. See 9.1 for more information about installing the optional Tray2.

To load paper, pull the tray and load the paper **with the print side up**.

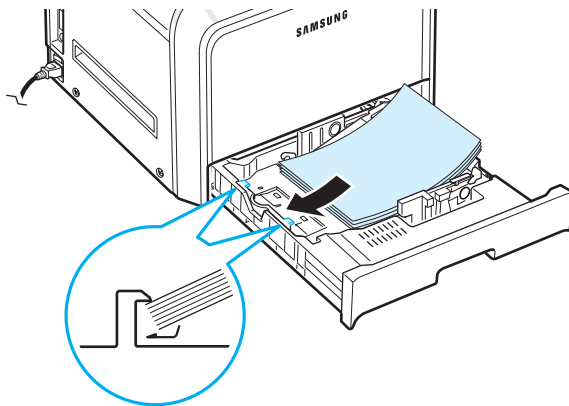

For details about loading paper in the paper tray, see "Loading Paper" on page 2.4.

**NOTE:** If you experience problems with paper feed, place one sheet at a time in the Multi-purpose Tray.

## Using the Optional Tray

The optional tray, Tray2, can hold a maximum of 500 sheets of plain paper.

To load paper in Tray2, follow the instructions for loading paper on page 2.4.

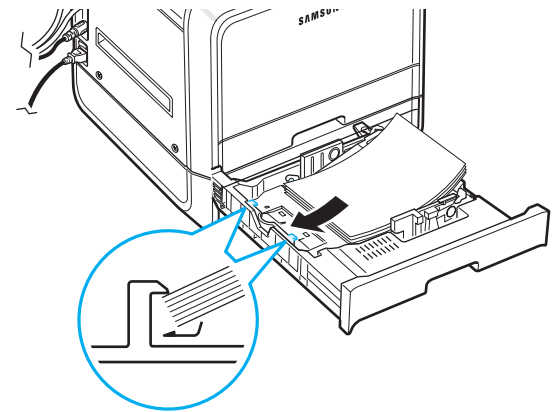

## Using the Multi-purpose Tray

The Multi-purpose Tray is located on the right side of your printer. It can be closed when not in use, making the printer more compact.

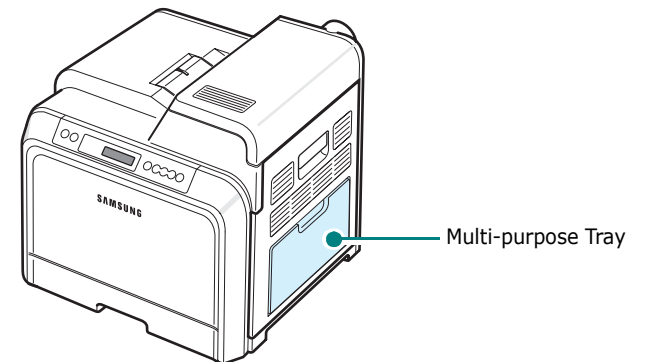

The Multi-purpose Tray can hold several sizes and types of material, such as cards and envelopes. You may also want to use the Multi-purpose Tray for single page print jobs on letterhead, colored paper for use as separator sheets, or other special materials that you do not normally keep in the paper tray. You can load approximately 100 sheets of plain paper, 10 envelopes, 10 sheets of card stock, or 10 labels at a time.

- Load only one size of print material at a time in the Multi-purpose Tray.
- To prevent paper jams, do not add paper when there is still paper in the Multi-purpose Tray. This also applies to other types of print materials.
- Print materials should be loaded face down with the top edge going into the Multi-purpose Tray first, and be placed in the center of the tray.



To load print material in the Multi-purpose Tray:

- 1 Lower the Multi-purpose Tray and unfold the paper support extension, as shown.

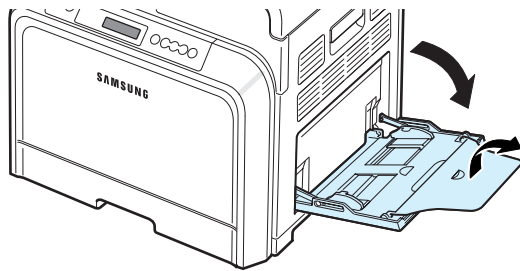

- 2 If you are using paper, flex or fan the edge of the paper stack to separate the pages before loading.

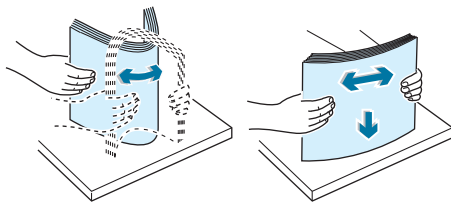

- 3 Load the print material **with the print side down**.

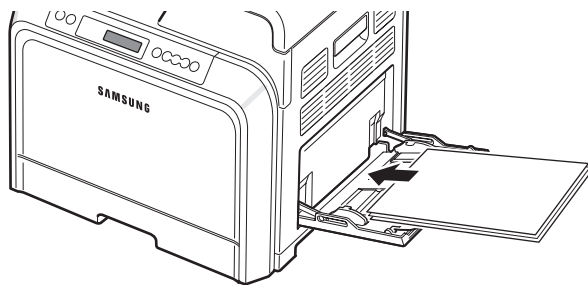

- 4 Squeeze the paper width guide and slide it to the edge of the print material without causing it to bend.

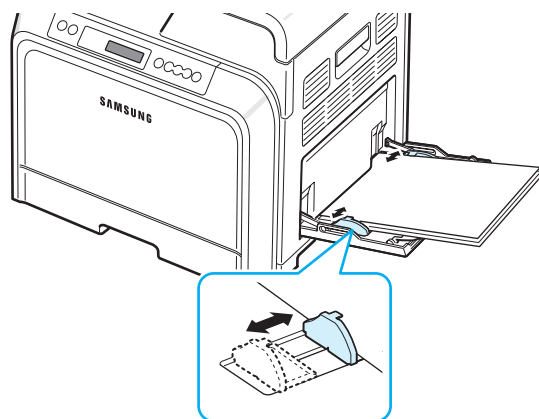

If you want to print on previously printed paper from the Multi-purpose Tray, the printed side should be facing up with the uncurled edge toward the printer. If you experience problems with the paper feeding, turn the paper around.

**NOTE:** Make sure that you have not loaded too much print material. The print material buckles if you load a stack that is too deep or if you push it in too far.

- 5 When you print a document, set the paper source to **Multi-Purpose Tray** and select the appropriate paper size and type in the software application. For details, see the **Software Section**.

**NOTE:** After printing, fold away the paper support extension and close the Multi-purpose Tray.

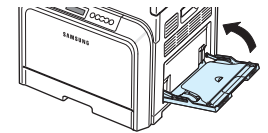

## Using the Manual Feed

You can manually load a sheet of print material in the Multi-purpose Tray if you select **Manual Feed** in the **Source** option from the **Paper** tab when you change print settings to print a document. For details about changing print settings, see the **Software Section**. Manually loading paper can be helpful when you want to check the print quality after each page is printed.

This loading procedure is almost the same as the procedure for loading in the Multi-purpose Tray, except you load paper sheet-by-sheet in the tray, send print data to print the first page, and press the **On Line/Continue** button (⏸) on the control panel to print each following page.

- 1 Lower the Multi-purpose Tray and unfold the paper support extension, as shown.
- 2 Load a sheet of print material **with the print side down**.

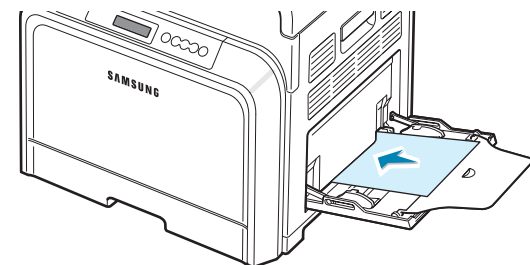

- 3 Squeeze the paper width guide and slide it to the edge of the paper without causing it to bend.

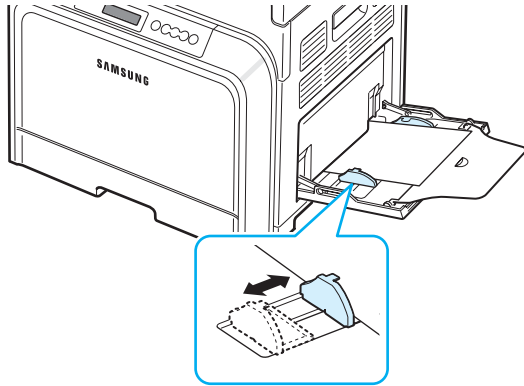

- 4 When you print a document, set the paper source to **Manual Feed** and select the appropriate paper size and type in the software application. For details, see the **Software Section**.
- 5 Print the document.
- 6 Press the **On Line/Continue** button (⋯).  
The printer picks up the print material and prints.

**NOTE:** If you don't press the button after a pause, the paper will automatically fed into the printer.

- 7 After one page is printed, insert the next sheet into the Multi-purpose Tray and press the **On Line/Continue** button (⋯).  
Repeat this step for every page to be printed.

## Printing on Special Print Materials

### Printing on Envelopes

- Load envelopes into the Multi-purpose Tray only.
- Only use envelopes recommended for laser printers. Before loading envelopes in the Multi-purpose Tray, make sure that they are undamaged and are not stuck together.
- Do not feed stamped envelopes.
- Never use envelopes with clasps, snaps, windows, coated linings, or self-stick adhesives.

To print on envelopes:

- 1 Open the Multi-purpose Tray and unfold the paper support.

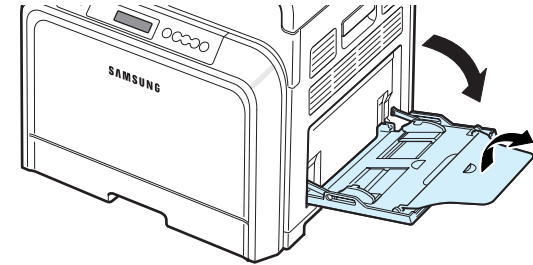

- 2 Flex or fan the edge of the envelope stack to separate them before loading.
- 3 Load the envelopes into the Multi-purpose Tray **with the flap side up**. The end of the envelope with the stamp area enters the printer first.

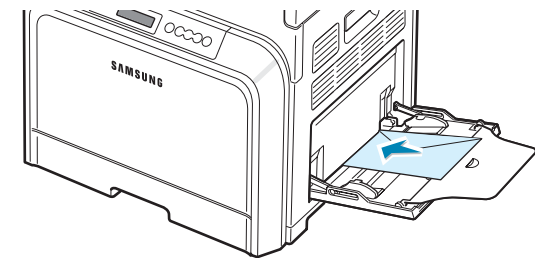

- 4 Squeeze the paper width guide and slide it to the edge of the envelope stack without causing it to bend.

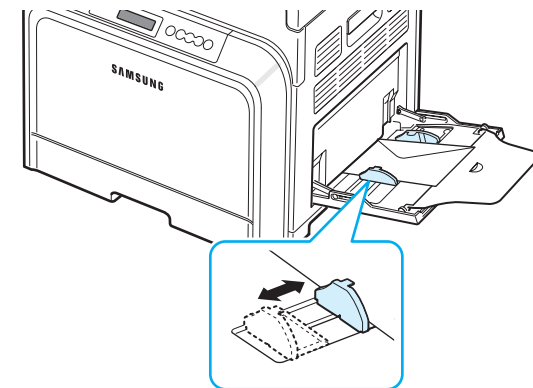

- 5 When you print, set the paper source to **Multi-Purpose Tray** and the paper type to **Envelope**, and select the appropriate size in the software application. For details, see the **Software Section**.

## Printing on Labels

- Only use labels recommended for laser printers.
- Verify that the labels' adhesive material can tolerate a fusing temperature of 180°C (356°F) for 0.1 seconds.
- Make sure that there is no exposed adhesive material between the labels. Exposed areas can cause labels to peel off during printing, which can cause paper jams. Exposed adhesive can also cause damage to printer components.
- Never print on the same sheet of labels more than once, or print on a partial sheet of labels.
- Do not use labels that are separating from the backing sheet or are wrinkled or damaged in any way.
- To prevent labels from sticking together, do not let the printed label sheets stack up as they are printed out.

To print on labels:

- 1 Open the Multi-purpose Tray and unfold the paper support.

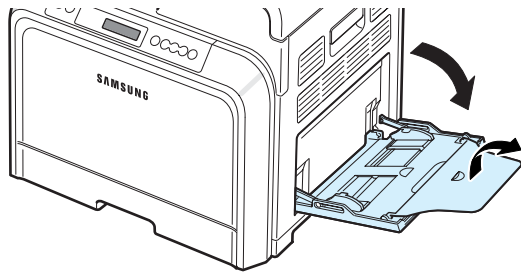

- 2 Load labels in the Multi-purpose Tray only, **with the print side down and the top, short edge in first**. Adjust the guide to fit the width of the labels.

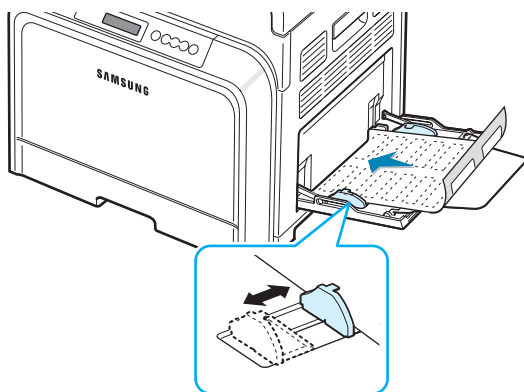

- 3 When you print, set the paper source to **Multi-Purpose Tray** and the paper type to **Labels**, and select the appropriate size in the software application. For details, see the **Software Section**.

## Printing on Preprinted Paper

- Preprinted paper is paper that has some type of printing on it before it is sent through the printer (paper that has a preprinted logo at the top of the page, for example).
- Letterhead must be printed with heat-resistant ink that will not melt, vaporize, or release hazardous emissions when subjected to the printer's fusing temperature of 180°C (356°F) for 0.1 seconds.
- Ink on letterhead must be non-flammable and should not adversely affect printer rollers.
- Forms and letterhead should be sealed in moisture-proof wrapping to prevent changes during storage.
- Before you load preprinted paper, such as forms and letterhead, verify that the ink on the paper is dry. During the fusing process, wet ink can come off of preprinted paper, reducing the print quality.

To print on preprinted paper:

- 1 Open the Multi-purpose Tray and unfold the paper support.

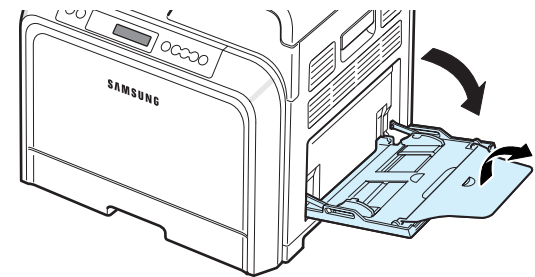

- 2 Load letterhead in the Multi-purpose Tray only, **with the print side down and the top and short edge first**. Adjust the guide to fit the edge of the paper stack.

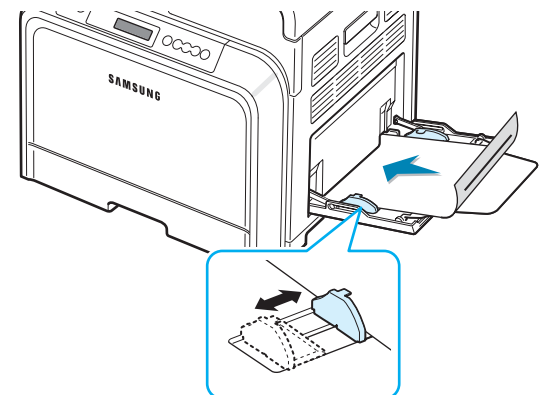

- 3 When you print, set the paper source to **Multi-Purpose Tray** and the paper type to **Preprinted**, and select the appropriate paper size in the software application. For details, see the **Software Section**.

## Printing on Card Stock or Custom-sized Materials

- Postcards, 3.5in. by 5.5in. (index) cards and other custom-sized materials can be printed with your printer. The minimum size is 3.5in. by 5.5in. (90mm by 140mm) and the maximum size is 8.5in. by 14in. (216mm by 356mm).
- Always insert the short edge into the Multi-purpose Tray first. If you want to print in landscape mode, make this selection using your software. Inserting the long edge first may cause a paper jam.
- Do not load more than 10 cards into the Multi-purpose Tray at a time.
- Do not print on material smaller than 90mm (3.5in.) wide or 140mm (5.5in.) long.
- In the software application, set margins at least 4.3mm away from the edges of the material.

To print on card stock:

- 1 Open the Multi-purpose Tray and unfold the paper support.

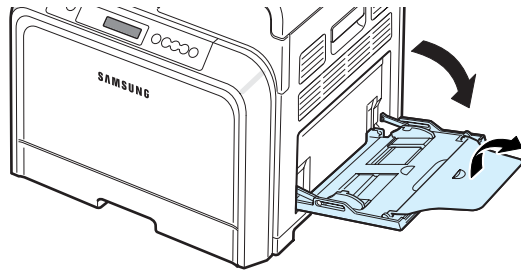

- 2 Load print material in the Multi-purpose Tray only, **with the print side down and the short edge first**. Slide the guide until it lightly touches the stack without causing it to bend.

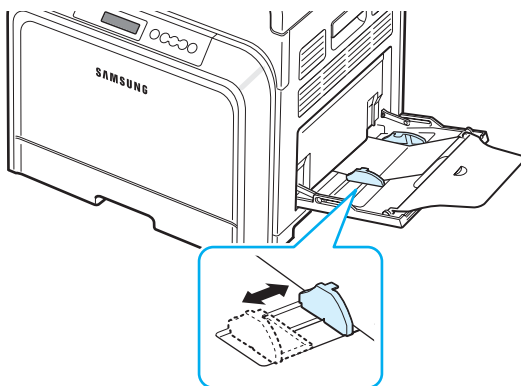

- 3 When you print, set the paper source to **Multi-Purpose Tray** and select the appropriate size and type in the software application. For details, see the **Software Section**.

If the size of your print material is not listed in the **Size** box in the **Paper** tab, click the **Custom** button and set the size manually.

---

**NOTE:** If you experience jams with card stock feeding, turn the paper around and try again.

---

# 5 Basic Printing

This chapter explains common printing tasks.

---

## Printing a Document

This printer allows you to print from various Windows applications, a Macintosh computer, or a Linux system. The exact steps for printing a document may vary depending on the application you use.

For details about printing, see the **Software Section**.

---

## Canceling a Print Job

If the print job is waiting in a print queue or print spooler, such as the printer group in Windows, delete the job as follows:

- 1 Click the Windows **Start** button.
- 2 For Windows 98SE/NT 4.0/2000/Me, select **Settings** and then **Printers**.  
For Windows XP/2003, select **Printers and Faxes**.
- 3 Double-click the **Samsung CLP-650 Series** icon.
- 4 From the **Document** menu, select **Cancel Printing** (Windows 98SE/Me) or **Cancel** (Windows NT 4.0/2000/XP/2003).

---

**NOTE:** You can access this window simply by double-clicking the printer icon at the bottom right corner of the Windows desktop.

---

You can also cancel the current job by pressing the **Cancel** button (⊗) on the control panel of your printer.

# 6 Maintaining Your Printer

This chapter provides information for maintaining your printer and the toner cartridges, as well as suggestions for high-quality and economical printing.

This chapter includes:

- **Printing a Configuration Page**
- **Replacing Supplies**
- **Managing Toner Cartridges**
- **Replacing Toner Cartridges**
- **Replacing the Paper Transfer Belt**
- **Replacing the Fuser Unit**
- **Cleaning the Printer**
- **Managing your Printer from the Website**

---

## Printing a Configuration Page

You can print a configuration page from the printer's control panel. Use the configuration page to view the current settings, to help troubleshoot problems, or to verify the installation of optional accessories, such as an optional tray.

To print a configuration page:

- 1** In ready mode, press the **Menu** button (Ⓜ) on the control panel.
- 2** When "Information" displays on the bottom line, press the **Enter** button (Ⓜ) to access the menu.
- 3** When "Configuration" displays on the bottom line, press the **Enter** button (Ⓜ).

A configuration page prints out.

## Replacing Supplies

From time to time, you need to replace the following items to maintain top performance and to avoid print quality problems and paper feed problems resulting from worn parts.

The following items should be replaced after you have printed the specified number of pages or when the life span of each item has expired. The SmartPanel program window will appear on the computer, indicating which item needs to be replaced. The display on the control panel will also show an error message, indicating which item needs to be replaced. See below.

Item(s) (Order number)	Printer Message	Pages Printed	See Page
Black toner cartridge (CLP-K600A)	Replace Black Toner	Approx. 4,000 pages*	6.4
Color toner cartridges (Cyan: CLP-C600A, Magenta: CLP- M600A, Yellow: CLP-Y600A)	Replace [Color] Toner	Approx. 4,000 pages*	6.4
Paper transfer belt (CLP-T600A)	Replace Transfer Belt	Approx. 35,000 pages**	6.5
Fuser unit (CLP-F650A)	Replace Fuser	Approx. 50,000 pages	6.7
Pick-up roller***	Replace MP Pick- roller OR Replace Tray1 Pick-roller OR Replace Tray2 Pick-roller	Approx. 50,000 pages	

\* Average A4-/letter-sized page count based on 5% coverage of individual colors on each page. Usage conditions and print patterns may cause results to vary.

\*\* The number of pages may be affected by operating environment, media type, and media size.

\*\*\*Contact a service representative.

To purchase replacement parts, contact your Samsung dealer or the retailer where you bought your printer. We strongly recommend that items be installed by a trained service professional, except for the toner cartridges (see 6.4), the paper transfer belt (see 6.5), and the fuser unit (see 6.7).

## Managing Toner Cartridges

### Toner Cartridge Storage

To get the maximum results from a toner cartridge, keep the following guidelines in mind:

- Do not remove toner cartridges from their packages until you are ready to use them.
- Do not refill toner cartridges. **The printer warranty does not cover damage caused by using a refilled cartridge.**
- Store toner cartridges in the same environment as the printer.
- To prevent damage to toner cartridges, do not expose them to light for more than a few minutes.

### Toner Cartridge Life Expectancy

The life of a toner cartridge depends on the amount of toner that your print jobs require. When printing text at 5% coverage, the toner cartridges last an average of 4,000 pages for black and each color.

### Redistributing Toner

When a toner cartridge is low on toner, faded or light areas may appear. It is also possible that colored images may be printed with incorrect colors due to flawed mixing of toner colors when one of the colored toner cartridges is low on toner. The SmartPanel program window appears on the computer telling you which color cartridge is low on toner. Also, the display on the control panel shows the error message, "Ready [Color] Low Toner".

The printer is able to continue to print using the current toner cartridge until the SmartPanel program window appears on the computer telling you to replace the cartridge, or the control panel displays that message.

You may be able to temporarily improve print quality by redistributing the toner. When the '[Color] Toner Empty' message appears, the printer will stop printing until a new toner cartridge put into the printer.

To redistribute the toner:

- 1 Using the handle, completely open the access door.

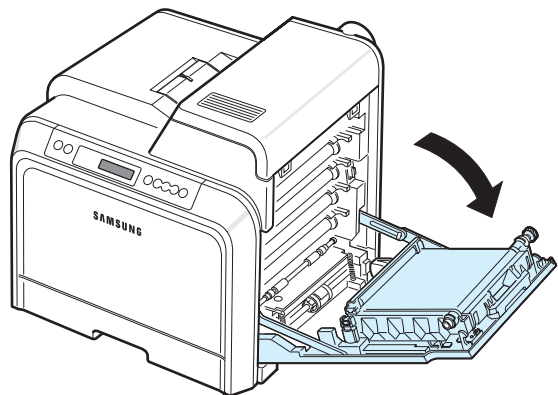

**CAUTION:**

- Do not touch the green surface, the OPC drum, on the front of the toner cartridge with your hands or any other material. Use the handle on each cartridge in order to avoid touching this area.
- Be careful not to scratch the surface of the paper transfer belt.
- If you leave the access door open for more than a few minutes, the OPC drum can be exposed to light. This will cause damage to the OPC drum. Close the access door should the installation need to be halted for any reason.

- 2 Grasp the handles on the toner cartridge and pull to remove the cartridge from the printer.

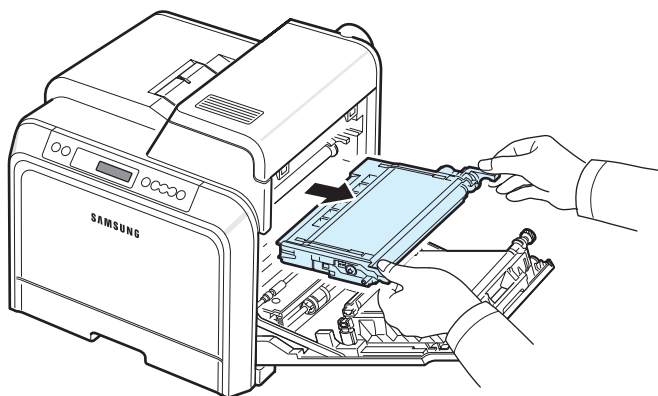

- 3 Holding both handles on the toner cartridge, gently rock it from side to side to redistribute the toner.

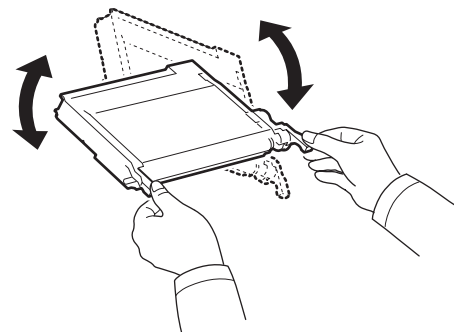

**NOTE:** If toner gets on your clothing, wipe it off with a dry cloth and wash it in cold water. Hot water sets toner into fabric.

- 4 Slide the toner cartridge back into the printer.

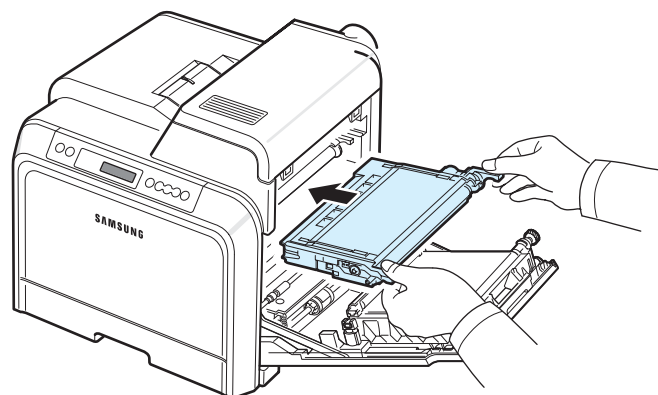

- 5 Close the access door. Make sure that the door is securely latched.

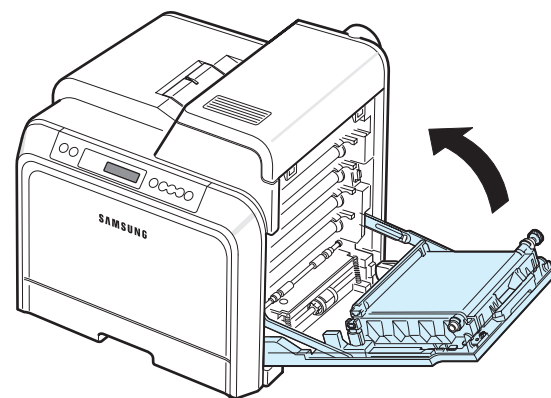

**CAUTION:** If the access door is not completely closed, the printer will not operate.



## Replacing Toner Cartridges

The printer uses four colors and has a different toner cartridge for each one: yellow (Y), magenta (M), cyan (C), and black (K).

When the Toner LEDs, (  ) on the control panel, indicating each individual toner cartridge according to its color, turn on, the printer stops printing. Also, the display on the control panel shows the error message, "[Color] Toner Empty". At this stage, replace the toner cartridge in question. When the '[Color] Toner Empty' message appears, the printer will stop printing until a new toner cartridge is put into the printer.

To replace the toner cartridge:

- 1 Turn the printer off, then wait a few minutes for the printer to cool.
- 2 Using the handle, completely open the access door.

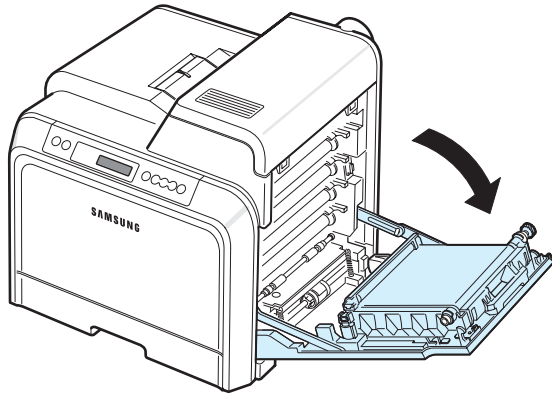

### CAUTION:

- Do not touch the green surface, the OPC drum, on the front of each toner cartridge with your hands or any other material. Use the handle on each cartridge in order to avoid touching this area.
- Be careful not to scratch the surface of the paper transfer belt.
- If you leave the access door open for more than a few minutes, the OPC drum can be exposed to light. This will cause damage to the OPC drum. Close the access door should the installation need to be halted for any reason.

- 3 Grasp the handles on the empty toner cartridge and pull to remove the cartridge from the printer.

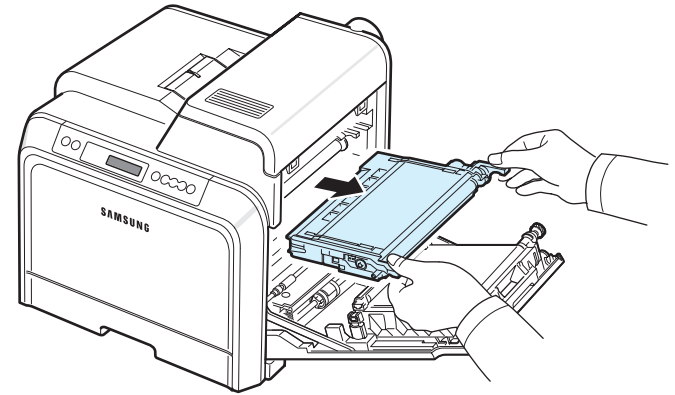

- 4 Take a new toner cartridge out of its package.

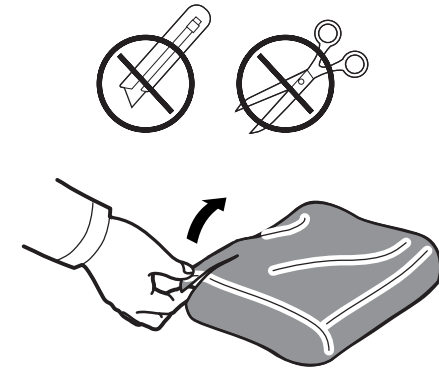

### CAUTION:

- Don't use sharp objects, such as a knife or scissors, to open the toner cartridge package. You could damage the surface of the toner cartridge.
- To prevent damage, do not expose the toner cartridge to light for more than a few minutes. Cover it with a piece of paper to protect it if necessary.

- 5 Holding both handles on the toner cartridge, gently rock it from side to side to evenly distribute the toner.

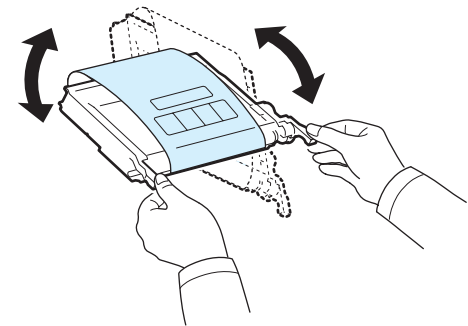

- 6 Place the toner cartridge on a flat surface, as shown, and remove the paper covering the toner cartridge by removing the tape.

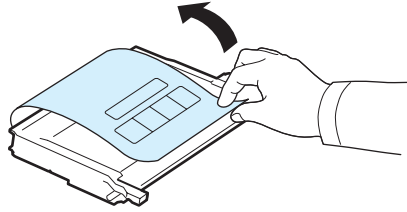

**NOTE:** If toner gets on your clothing, wipe it off with a dry cloth and wash it in cold water. Hot water sets toner into fabric.

- 7 Make sure that the color of the toner cartridge matches the color slot and then grasp the handles on the toner cartridge. Insert the cartridge until it clicks into place.

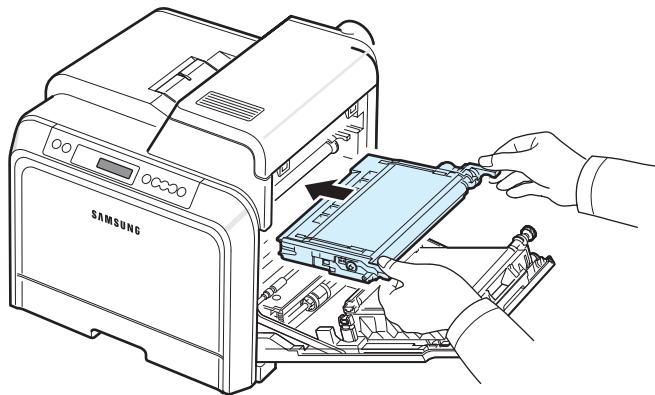

- 8 Close the access door. Make sure that the door is securely latched, and then turn the printer on.

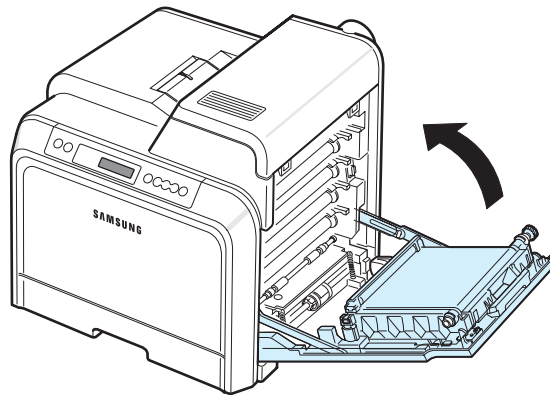

**CAUTION:** If the access door is not completely closed, the printer will not operate.

## Replacing the Paper Transfer Belt

The life of the paper transfer belt is approximately 35,000 black and color pages. When the life span of the paper transfer belt has expired, the printer will stop printing until a new paper transfer belt is placed into the printer.

The SmartPanel program window appears on the computer, indicating the paper transfer belt needs to be replaced. The display on the control panel shows the error message, "Replace Transfer Belt". At this stage, replace the paper transfer belt.

**NOTE:** The life span of the paper transfer belt May be affected by operating environment, printing interval, media type, and media size.

To replace the paper transfer belt:

- 1 Turn the printer off, then wait a few minutes for the printer to cool.
- 2 Using the handle, completely open the access door.

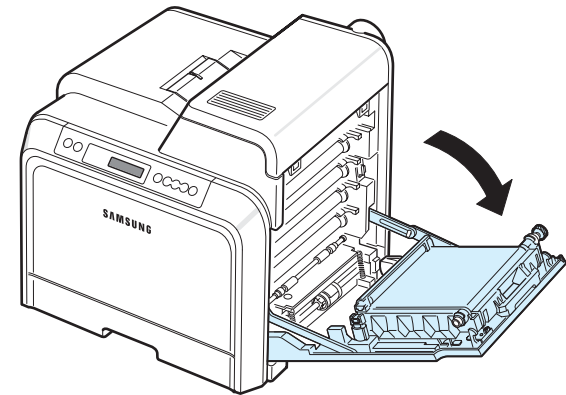

### CAUTION:

- Do not touch the green surface, the OPC drum, on the front of each toner cartridge with your hands or any other material. Use the handle on each cartridge in order to avoid touching this area.
- If you leave the access door open for more than a few minutes, the OPC drum can be exposed to light. This will cause damage to the OPC drum. Close the access door should the installation need to be halted for any reason.

- 3** Locate the green release button on the inside of the access door (near the left side of the paper transfer belt). Press the button to release the paper transfer belt. Holding the handle on the paper transfer belt, lift it out of the printer.

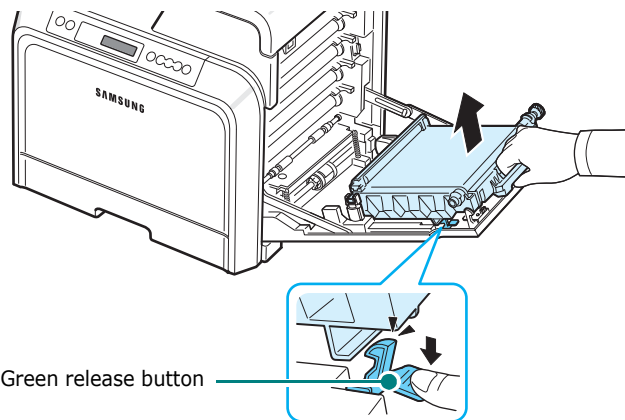

- 4** Take a new paper transfer belt out of its package.

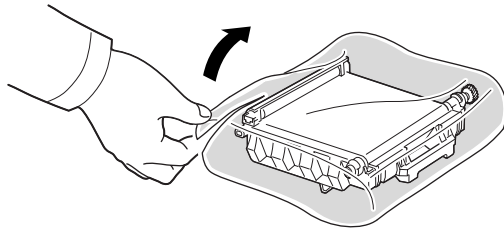

- 5** Remove the paper covering the paper transfer belt by removing the tape.



**CAUTION:**

- Don't use sharp objects, such as a knife or scissors, to open the paper transfer belt package. You could damage the surface of the paper transfer belt.
- Be careful not to scratch the surface of the paper transfer belt.

- 6** Holding the handle on the new paper transfer belt, align it with the slots on the inside of the access door.

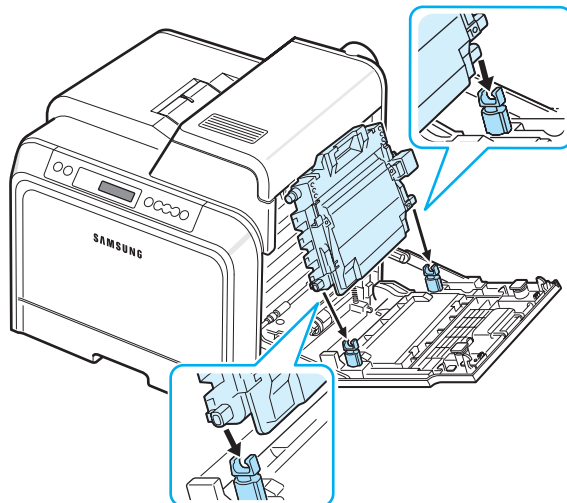

- 7** Push down until it clicks into place. Then lower the paper transfer belt until it is parallel with the access door and firmly seated. The green release button automatically locks the paper transfer belt.

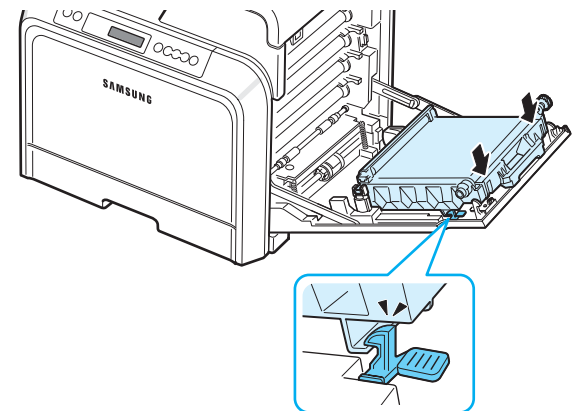

- 8** Close the access door firmly.

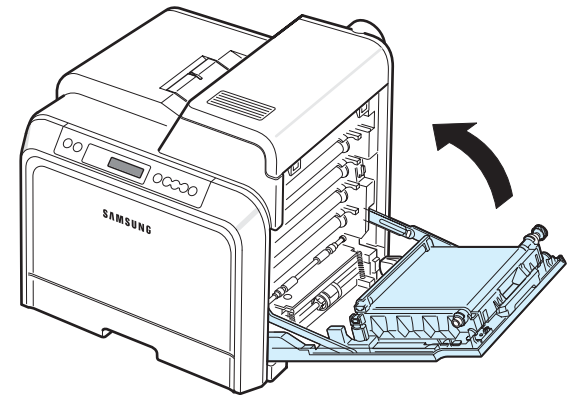

**CAUTION:** If the access door is not completely closed, the printer will not operate.

- 9** Turn the printer on.

## Replacing the Fuser Unit

The life of the fuser unit is approximately 50,000 black and color pages. When the life span of the fuser unit has expired, the printer will stop printing until a new fuser unit is placed into the printer.

The SmartPanel program window appears on the computer, indicating the fuser unit needs to be replaced. Also, the display on the control panel shows the error message, "Replace Fuser". At this stage, replace the fuser unit.

**NOTE:** The life span of the fuser unit May be affected by operating environment, printing interval, media type, and media size.

To replace the fuser unit:

- 1 Turn the printer off, then wait a few minutes for the printer to cool.
- 2 Using the handle, completely open the access door.

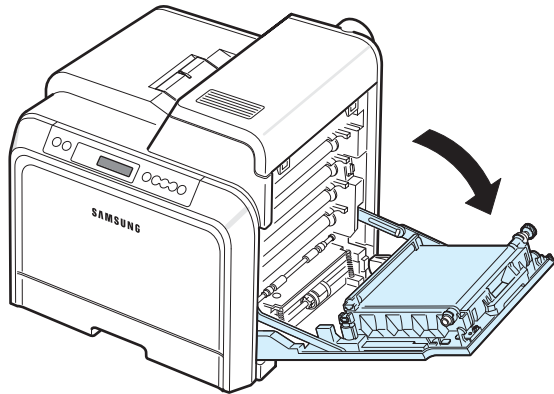

### CAUTION:

- Do not touch the green surface, the OPC drum, on the front of each toner cartridge with your hands or any other material. Use the handle on each cartridge in order to avoid touching this area.
- Be careful not to scratch the surface of the paper transfer belt.
- If you leave the access door open for more than a few minutes, the OPC drum can be exposed to light. This will cause damage to the OPC drum. Close the access door should the installation need to be halted for any reason.

- 3 Open the top cover.

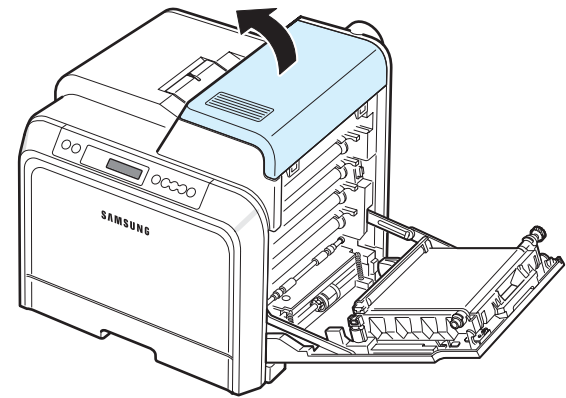

- 4 Using a copper coin or a screwdriver, remove the two screws on both sides of the fuser unit. Then using the handle, pull the fuser unit straight out.

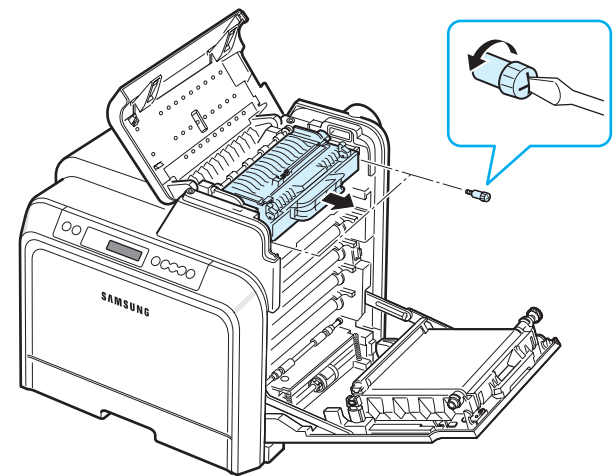

- 5 Unpack a new fuser unit and insert it into the printer.
- 6 Tighten the two screws.
- 7 After making sure that the access door is open, close the top cover. Make sure that it is securely latched.
- 8 Close the access door firmly.



**CAUTION:** If the top cover and access door are not completely closed, the printer will not operate.

- 9 Reconnect the power cord and cables and then turn the printer on.

## Cleaning the Printer

During the printing process, particles of paper, toner, and dust can accumulate inside the printer. Over time, this build-up can cause print quality problems such as toner specks or smearing. Your printer has a cleaning mode that can correct and prevent these types of problems.

## Cleaning the Outside of the Printer

Clean the printer cabinet with a soft lint-free cloth. You can dampen the cloth slightly with water, but be careful not to let any water drip onto the printer or inside of it.



**CAUTION:** Cleaning the printer cabinet with cleaners containing large amounts of alcohol, solvents, or other strong substances can discolor or crack the cabinet.

## Cleaning the Inside of the Printer

**NOTE:** While cleaning the inside of the printer, be careful not to touch the transfer roller. Oil from your fingers can cause print quality problems.

- 1 Turn the printer off and unplug the power cord, then wait a few minutes for the printer to cool.
- 2 Using the handle, completely open the access door.

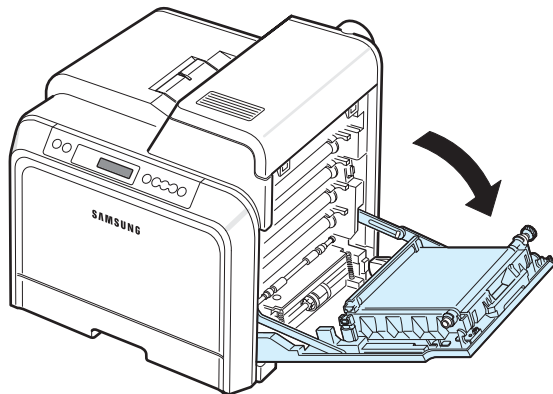

**CAUTION:**

- Do not touch the green surface, the OPC drum, on the front of each toner cartridge with your hands or any other material. Use the handle on each cartridge in order to avoid touching this area.
- Be careful not to scratch the surface of the paper transfer belt.
- If you leave the access door open for more than a few minutes, the OPC drum can be exposed to light. This will cause damage to the OPC drum. Close the access door should the installation need to be halted for any reason.

- 3 Grasp the handles on each toner cartridge and pull to remove the cartridges from the printer. Set them on a clean flat surface.

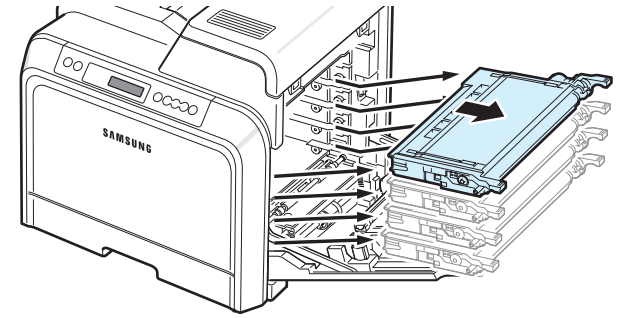

**CAUTION:** To prevent damage, do not expose the toner cartridges to light for more than a few minutes. Cover them with paper to protect them if necessary.

- 4 Look inside the printer. Remove any dust, paper particles, and spilled toner with a damp, soft lint-free cloth, or small vacuum cleaner.

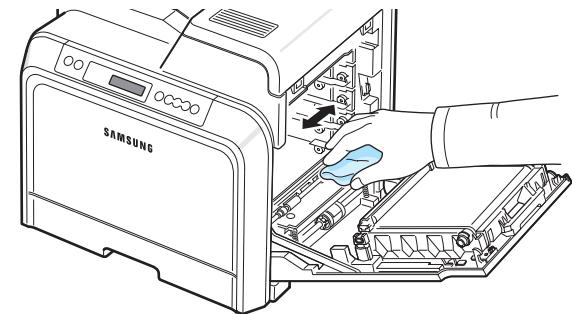

**NOTE:** After cleaning, allow the printer to dry completely.

- 5 Look inside the printer on the right and then locate the colors of the toner cartridges that match the colors of the slots.

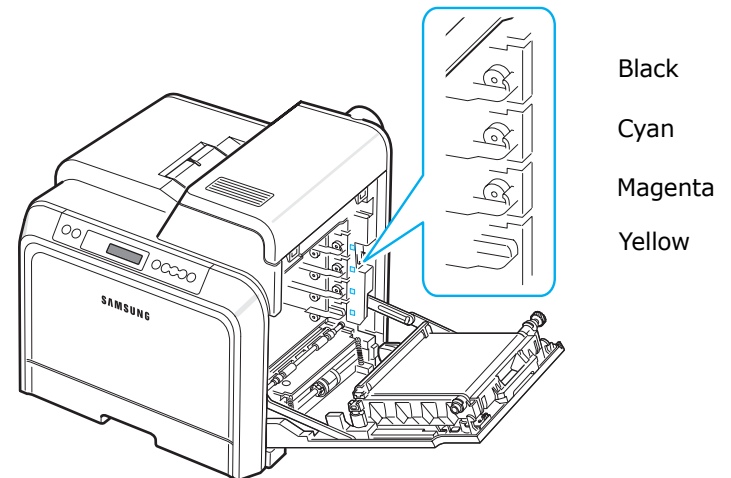

- 6** Grasp the handles on each toner cartridge. Align the toner cartridges with the slots inside the printer and insert them into their corresponding positions in the following order: Yellow, Magenta, Cyan, and then Black, until they click into place.

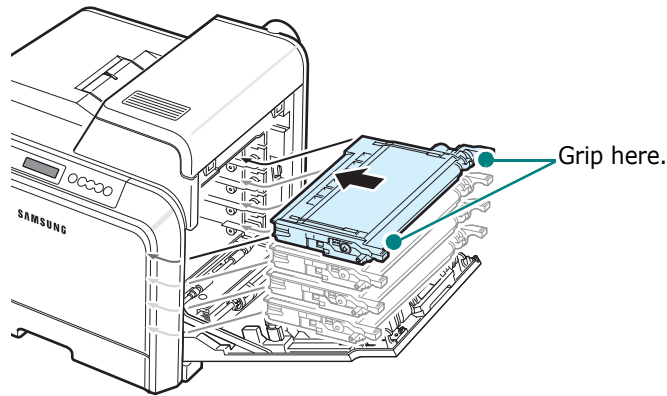

- 7** Close the access door. Make sure that the door is securely latched.

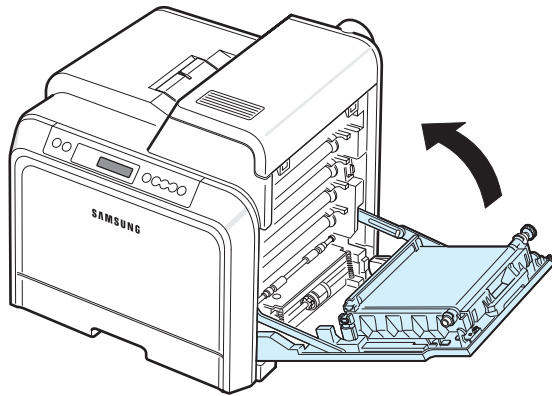

**CAUTION:** If the access door is not completely closed, the printer will not operate.

- 8** Plug the power cord in and turn the printer on.

## Managing your Printer from the Website

If you have connected your printer to a network and set up TCP/IP network parameters correctly, you can manage the printer via **SyncThru Web Service**, web-based service embedded to your printer. Use **SyncThru Web Service** to:

- View the printer's device information and check its current status.
- Set up network parameters.
- Change the print properties.
- Set the printer to send email notification to let you know the printer's status.
- Get support for using the printer.

To access **SyncThru Web Service**:

- 1** Start a web browser, such as Internet Explorer from Windows.
- 2** Enter the printer's IP address (<http://xxx.xxx.xxx.xxx>) in the address field and press the **Enter** key or click **Go**.  
Your printer's embedded web page opens.

# 7 Solving Problems

This chapter provides helpful information for what to do if you encounter an error while using your printer.

This chapter includes:

- **Troubleshooting Checklist**
- **Solving General Printing Problems**
- **Clearing Paper Jams**
- **Solving Print Quality Problems**
- **Understanding Display Messages**
- **Common Windows Problems**
- **Common Macintosh Problems**
- **Common Linux Problems**

## Troubleshooting Checklist

If the printer is not working properly, consult the following checklist. If the printer does not pass a step, follow the corresponding troubleshooting suggestions.

Status	Response
Make sure that the <b>On Line/Continue</b> button on the control panel is green and "Ready" is shown on the SmartPanel program window or the control panel display.	<ul style="list-style-type: none"><li>• If the button light is off, check the power cord connection. Check the power switch. Check the power source by plugging the power cord into another outlet.</li><li>• If the button light is red, check the display message and go to "Understanding Display Messages" on page 7.14.</li></ul>
Print a demo page to verify that the printer is feeding paper correctly. See 2.8.	<ul style="list-style-type: none"><li>• If a demo page does not print, check the paper supply in the paper tray.</li><li>• If the paper jams in the printer, go to "Clearing Paper Jams" on page 7.4.</li><li>• If an error message appears on the display, go to "Understanding Display Messages" on page 7.14.</li></ul>
Check the demo page to see if it is printed correctly.	If there is a print quality problem, go to "Solving Print Quality Problems" on page 7.12.
Print a short document from a software application to verify that the computer and printer are connected and are communicating correctly.	<ul style="list-style-type: none"><li>• If the page does not print, check the cable connection between the printer and the computer.</li><li>• Check the print queue or print spooler to see if the printer has been paused.</li><li>• Check the software application to ensure that you are using the proper printer driver and communication port. If the page is interrupted during printing, go to "Solving General Printing Problems" on page 7.2.</li></ul>
If completing the checklist does not resolve the printer problem, check the following troubleshooting sections.	<ul style="list-style-type: none"><li>• See "Solving General Printing Problems" on page 7.2.</li><li>• See "Understanding Display Messages" on page 7.14.</li><li>• See "Common Windows Problems" on page 7.17.</li><li>• See "Common Macintosh Problems" on page 7.17.</li><li>• See "Common Linux Problems" on page 7.18.</li></ul>

# Solving General Printing Problems

For problems with the operation of your printer, refer to the table for suggested solutions.

Problem	Possible Cause	Solution
The printer does not print.	The printer is not receiving power.	Check the power cord connections. Check the power switch and the power source.
	The printer is not selected as the default printer.	Select <b>Samsung CLP-650 Series</b> as your default printer.
	Check the printer for the following: <ul style="list-style-type: none"> <li>The printer cover is not closed.</li> <li>Paper is jammed.</li> <li>No paper is loaded.</li> <li>The toner cartridge is not installed.</li> </ul>	After locating the problem, clear it. If a printer system error occurs, contact your service representative. <ul style="list-style-type: none"> <li>Close the printer cover.</li> <li>Clear the paper jam. See 7.4.</li> <li>Load paper. See 2.4.</li> <li>Install the toner cartridge. See 2.2.</li> </ul>
	The printer may be in manual feed mode and out of paper.	Check the message on the SmartPanel program window or the control panel display, add paper to the Multi-purpose Tray, and press the <b>On Line/Continue</b> button on the printer's control panel.
	The connection cable between the computer and the printer is not connected properly.	Disconnect the printer cable and reconnect it.
	The connection cable between the computer and the printer is defective.	If possible, attach the cable to another computer that is working properly and try to print a document. You can also try using a different printer cable.
	The port setting is incorrect.	Check the Windows printer setting to make sure that the print job is sent to the correct port. If the computer has more than one port, make sure that the printer is attached to the correct one.

Problem	Possible Cause	Solution
The printer does not print. (continued)	The printer may be configured incorrectly.	Check the printer properties to ensure that all of the print settings are correct.
	The printer driver may be incorrectly installed.	Reinstall the printer driver; see the <b>Software Section</b> . Try printing a demo page.
	The printer is malfunctioning.	Check the display message on the control panel to determine if the printer is indicating a system error.
The printer selects print materials from the wrong paper source.	The paper source selection in the printer properties may be incorrect.	For many software applications, the paper source selection is found under the <b>Paper</b> tab within the printer properties window. Select the correct paper source. For details, see the <b>Software Section</b> .
Paper does not feed into the printer.	Paper has been loaded incorrectly.	Remove paper from the tray and reload it correctly. Check that the paper size adjusters are set correctly.
	There is too much paper in the paper tray.	Remove excess paper from the tray.
	The paper is too thick.	Use only paper that meets printer specifications.
A print job is extremely slow.	The job may be very complex.	Reduce the complexity of the page(s) or try adjusting the print quality settings. Adjust the print quality settings, such as reducing the resolution. If you have set the resolution to <b>Best</b> , change it to <b>Normal or Draft</b> . See the <b>Software Section</b> . Change the port setting to the USB or network port to improve print speed. Your printer prints A4-sized paper at 20 ppm and letter-sized paper at 21 ppm.
	If using Windows 98SE/Me, the Spooling Setting may be set incorrectly.	From the <b>Start</b> menu, choose <b>Settings and Printers</b> . Right-click the <b>Samsung CLP-650 Series</b> printer icon, choose <b>Properties</b> , click the <b>Details</b> tab, and then choose the <b>Spool Settings</b> button. Select the desired spool setting.







Problem	Possible Cause	Solution
Half the page is blank.	The page orientation setting may be incorrect.	Change the page orientation in your application. For details, see the <b>Software Section</b> .
	The paper size and the paper size settings do not match.	Ensure that the paper size in the printer driver settings matches the paper in the tray. Or, ensure that the paper size in the printer driver settings matches the paper selection in the software application settings you use.
The paper keeps jamming.	There is too much paper in the paper tray.	Remove excess paper from the tray. If printing on special materials, use the Multi-purpose Tray. Check that the paper size adjusters are set correctly.
	An incorrect type of paper is being used.	Use only paper that meets printer specifications. If printing on special materials, use the Multi-purpose Tray.
	There may be debris inside the printer.	Open the access door and remove the debris.
The printer prints, but the text is wrong, garbled, or incomplete.	The printer cable is loose or defective.	Disconnect and reconnect the printer cable. Try a print job that you have already printed successfully. If possible, attach the cable and printer to another computer and try a print job that you know works. Finally, try a new printer cable.
	The wrong printer driver was selected.	Check the application's printer selection menu to ensure that your printer is selected.
	The software application is malfunctioning.	Try printing a job from another application.
	The operating system is malfunctioning.	Exit Windows and reboot the computer. Turn the printer off and then back on again.

Problem	Possible Cause	Solution
Pages print, but are blank.	The toner cartridge is defective or out of toner.	Redistribute the toner. If necessary, see page 6.2. If necessary, replace the toner cartridge.
	The file may have blank pages.	Check the file to ensure that it does not contain blank pages.
	Some parts, such as the controller or the board, may be defective.	Contact a service representative.
When you are using Windows 98SE, the illustrations print incorrectly from Adobe Illustrator.	The setting in the software application is wrong.	Select <b>Download as Bit Image</b> in the <b>Advanced Options</b> window of the graphic properties window. Print the document again.
The print quality of photos is not good. Images are not clear.	The resolution is set to <b>Normal or Draft</b> .	Change the resolution to <b>Best</b> and then try to print again.
	The resolution of the photo is very low.	If you increase the photo size in the software application, the resolution will be reduced. Reduce the photo size.
Your printer has an odd smell during initial use.	The oil used to protect the fuser is evaporating.	After printing about 100 color pages, there will be no more smell. It is a temporary issue.

## Clearing Paper Jams

**NOTE:** When removing paper that is jammed in the printer, if possible always pull the paper in the direction that it normally moves so as not to damage internal components. Always pull firmly and evenly; do not jerk the paper. If the paper tears, ensure that all fragments of paper are removed; otherwise a jam will occur again.

When a paper jam occurs, a lamp turns on at the corresponding location on the Status map of the control panel. The display on the control panel also tells you where the paper jam has occurred. Refer to the table below to locate the paper jam and to clear it:

LED on Status Map	Message	Location of Jam	GoTo
	Jam0 In Tray1	In the paper feed area	page 7.4
	Jam0 In MP Tray	In the multi-purpose tray	page 7.5
	Jam Inside Printer	Inside printer	page 7.6
	Jam In Exit Area	In the paper exit area	page 7.7
	Jam0 In Tray2	In the optional Tray2	page 7.9

To resume printing after clearing paper jams, you must open and close the access door.

## In the Paper Feed Area

If paper is jammed in the paper feed area, a lamp turns on at the corresponding location on the Status map. Also, "Jam0 In Tray1" appears on the display.

- 1 Using the handle, completely open the access door.

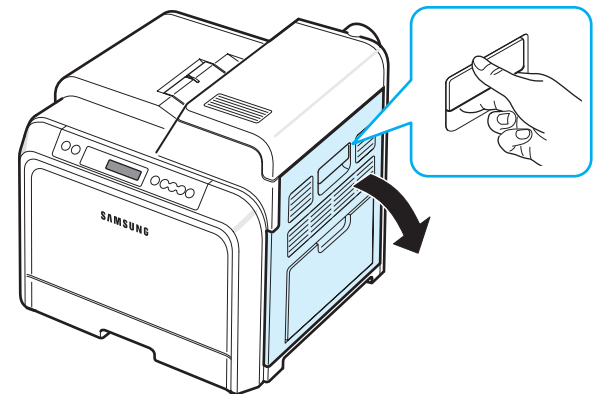

- 2 Carefully remove the paper by pulling in the direction as shown below. Go to step 6.

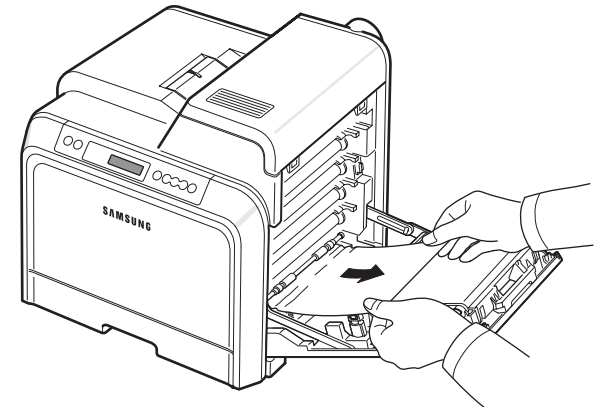

If you cannot find the jammed paper, or if there is any resistance removing the paper, stop pulling, and go to step 3.



### CAUTION:

- Do not touch the green surface, the OPC drum, on the front of each toner cartridge with your hands or any other material. Use the handle on each cartridge in order to avoid touching this area.
- Be careful not to scratch the surface of the paper transfer belt.
- If you leave the access door open for more than a few minutes, the OPC drum can be exposed to light. This will cause damage to the OPC drum. Close the access door should the installation need to be halted for any reason.

- 3** Pull the tray open. After you pull it all the way out, lift up the front part of the tray slightly to release the tray from the printer.

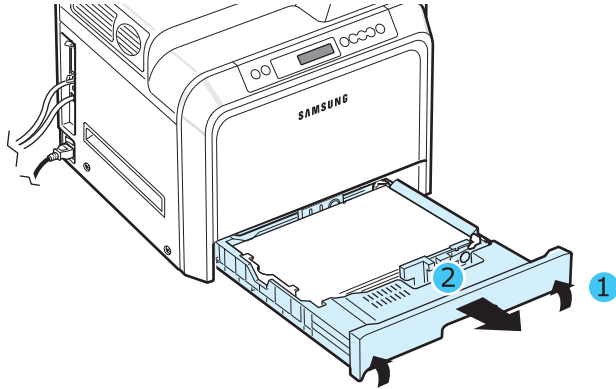

- 4** Remove the jammed paper by gently pulling it straight out as shown below.

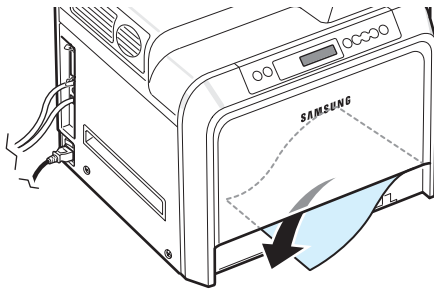

- 5** To replace the tray, lower the rear edge, align it with the slot, and slide it into the printer.

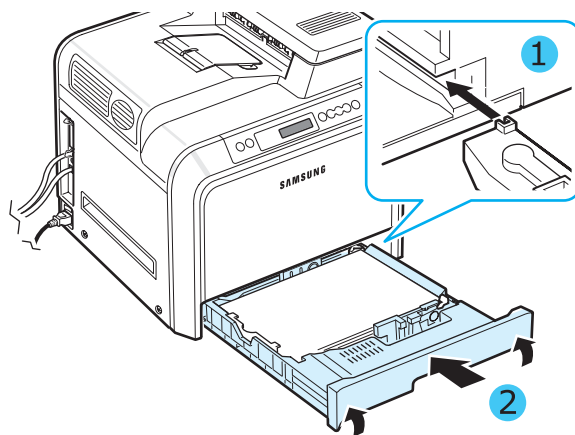

- 6** After removing the jammed paper, check for paper which may be jammed in other parts of the printer.

- 7** Close the access door firmly. The printer will resume printing.



**CAUTION:** If the access door is not completely closed, the printer will not operate.

## In the Multi-purpose Tray

When you print using the Multi-purpose Tray and the printer detects that there is either no paper or the paper has been improperly loaded, a lamp turns on at the corresponding location on the Status map. Also, "Jam0 In MP Tray" appears on the display.

- 1** If the paper is not feeding properly, using the handle, completely open the access door.

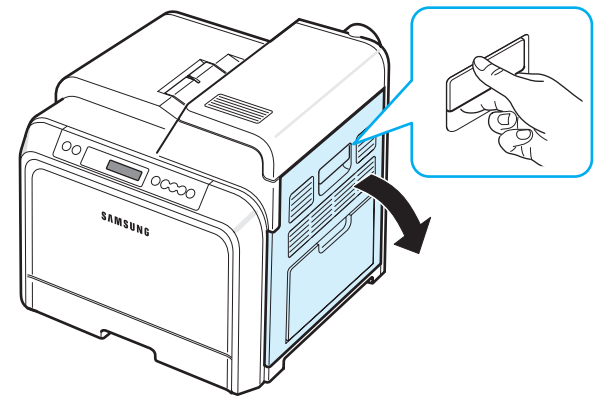

- 2** Remove the jammed paper by pulling in the direction shown. To avoid tearing the paper, pull it out gently and slowly.

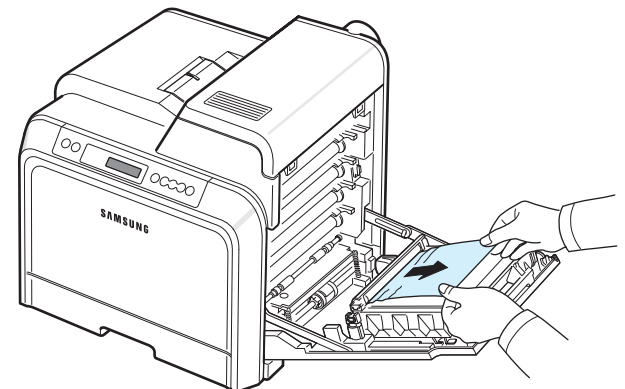

**CAUTION:**

- Do not touch the green surface, the OPC drum, on the front of each toner cartridge with your hands or any other material. Use the handle on each cartridge in order to avoid touching this area.
- Be careful not to scratch the surface of the paper transfer belt.
- If you leave the access door open for more than a few minutes, the OPC drum can be exposed to light. This will cause damage to the OPC drum. Close the access door should the installation need to be halted for any reason.

- 3** Close the access door firmly. The printer will resume printing.



**CAUTION:** If the access door is not completely closed, the printer will not operate.

## Inside the Printer

If paper is jammed inside the printer, a lamp turns on at the corresponding location on the Status map. Also, "Jam Inside Printer" appears on the display.

- 1** Using the handle, completely open the access door.

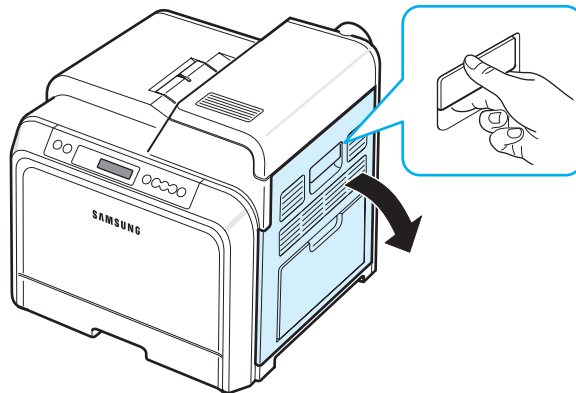

- 2** Open the top cover.

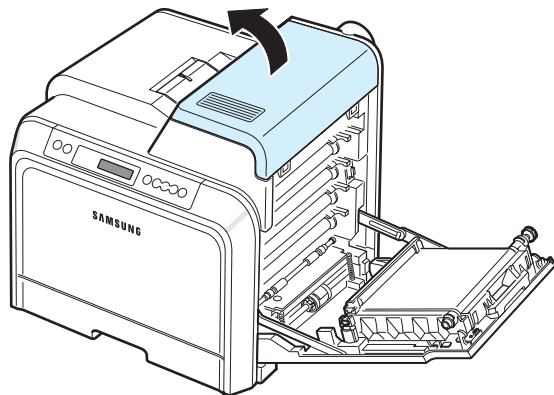

- 3** Push the levers up.

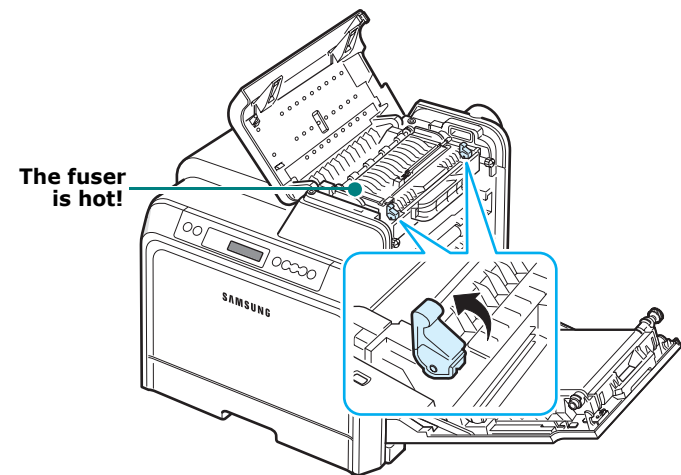

- 4** Open the inner cover using the handle on it and carefully take the jammed paper out of the printer.

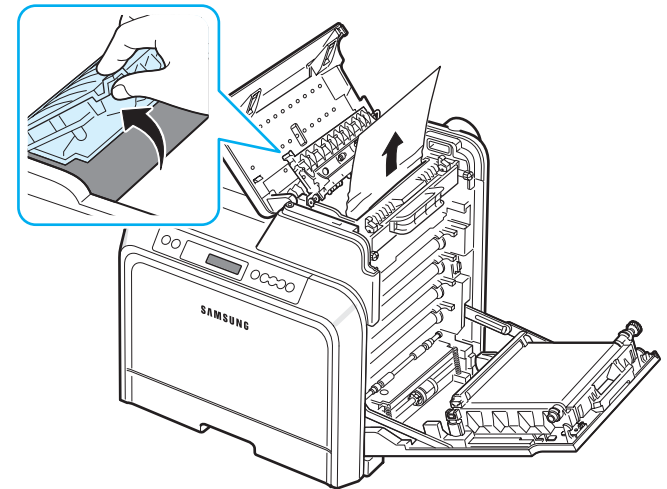

- 5** Close the inner cover and push the levers down.

**CAUTION:**

- Do not touch the fuser inside the inner cover. It is hot and could cause burns! The fuser's operating temperature is 180°C (356°F). Take care when removing paper from the printer.
- Do not touch the green surface, the OPC drum, on the front of each toner cartridge with your hands or any other material. Use the handle on each cartridge in order to avoid touching this area.
- Be careful not to scratch the surface of the paper transfer belt.
- If you leave the access door open for more than a few minutes, the OPC drum can be exposed to light. This will cause damage to the OPC drum. Close the access door should the installation need to be halted for any reason.

**6** After removing the jammed paper, check for paper which may be jammed in other parts of the printer.

**7** After making sure that the access door is open, close the top cover. Make sure that it is securely latched.

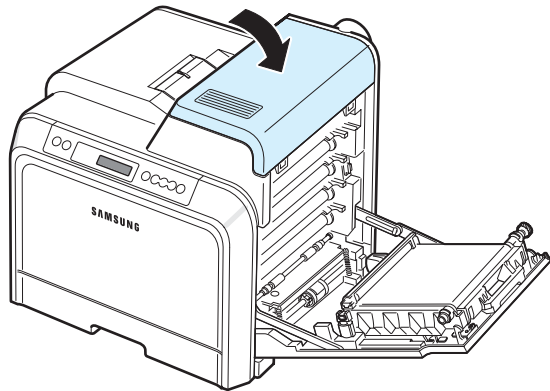

**8** Close the access door firmly. The printer will resume printing.



**CAUTION:** If the top cover and access door are not completely closed, the printer will not operate.

## In the Paper Exit Area

If paper is jammed in the paper exit area, a lamp turns on at the corresponding location on the Status map. Also, "Jam In Exit Area" appears on the display.

**1** If a long portion of the paper is visible, pull it straight out. Open and close the access door firmly. The printer will resume printing.

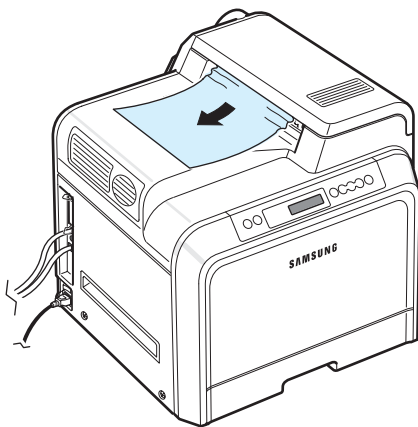

If you cannot find the jammed paper, or if there is any resistance removing the paper, stop pulling and go to step 2.

**2** Using the handle, completely open the access door.

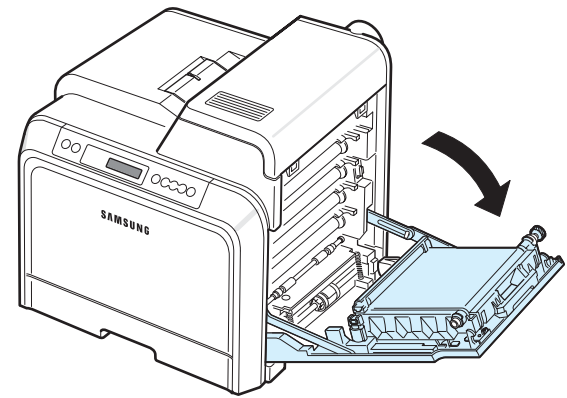

### CAUTION:

- Do not touch the green surface, the OPC drum, on the front of each toner cartridge with your hands or any other material. Use the handle on each cartridge in order to avoid touching this area.
- Be careful not to scratch the surface of the paper transfer belt.
- If you leave the access door open for more than a few minutes, the OPC drum can be exposed to light. This will cause damage to the OPC drum. Close the access door should the installation need to be halted for any reason.

**3** Open the top cover.

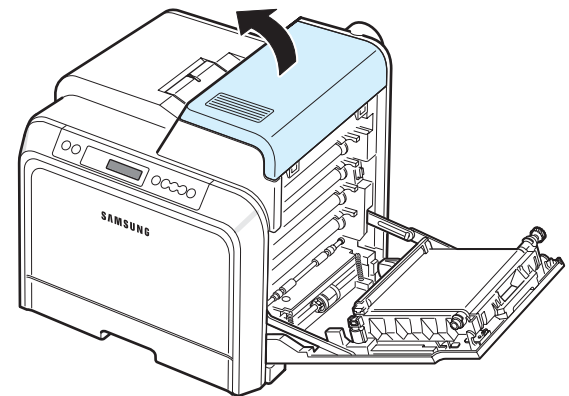

- 4 Push the levers up.

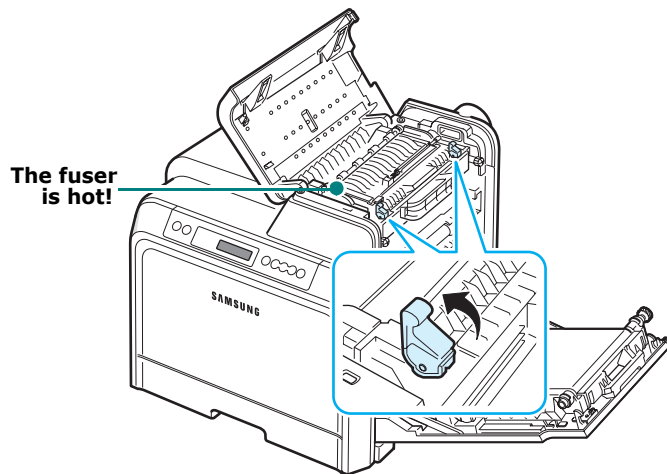

- 5 Open the inner cover using the handle on it and carefully take the jammed paper out of the printer.

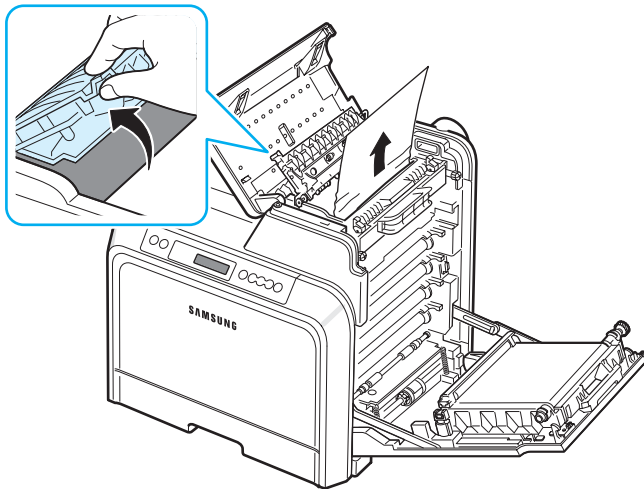

- 6 Close the inner cover and push the levers down.



**CAUTION:** Do not touch the fuser inside the inner cover. It is hot and could cause burns! The fuser's operating temperature is 180°C (356°F). Take care when removing paper from the printer.

- 7 After removing the jammed paper, check for paper which may be jammed in other parts of the printer.

- 8 After making sure that the access door is open, close the top cover. Make sure that it is securely latched.

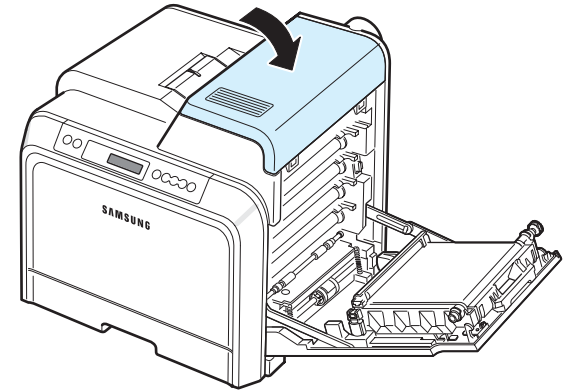

- 9 Close the access door firmly. The printer will resume printing.

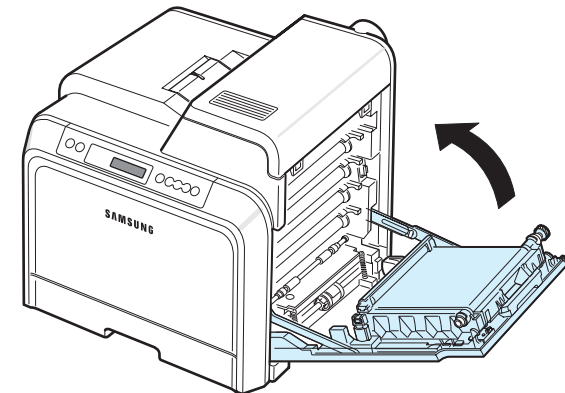

**CAUTION:** If the top cover and access door are not completely closed, the printer will not operate.

## In the Optional Tray2

If paper is jammed in the optional Tray2, a lamp turns on at the corresponding location on the Status map. Also, "Jam0 In Tray2" appears on the display.

- 1 Using the handle, completely open the access door.

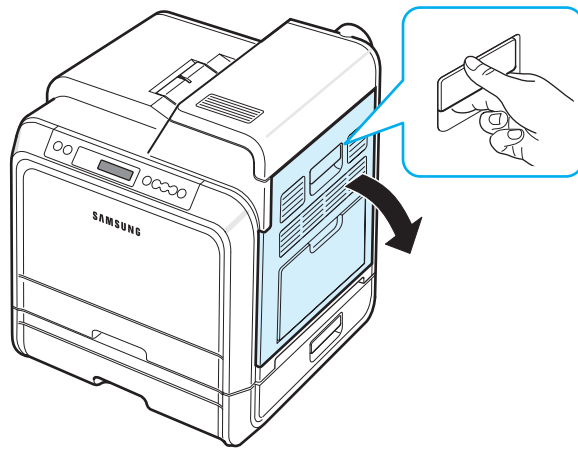

- 2 Open the top cover.

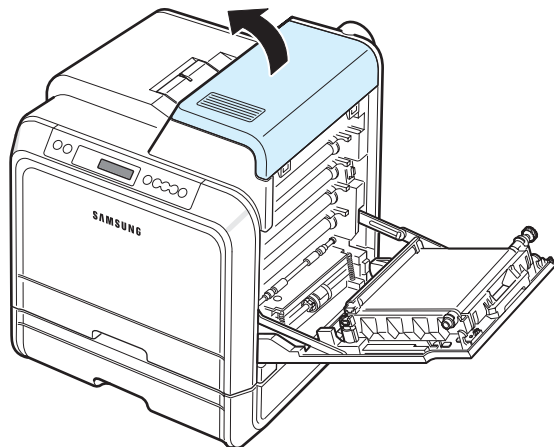

### CAUTION:

- Do not touch the fuser inside the inner cover. It is hot and could cause burns! The fuser's operating temperature is 180°C (356°F). Take care when removing paper from the printer.
- Do not touch the green surface, the OPC drum, on the front of each toner cartridge with your hands or any other material. Use the handle on each cartridge in order to avoid touching this area.
- Be careful not to scratch the surface of the paper transfer belt.
- If you leave the access door open for more than a few minutes, the OPC drum can be exposed to light. This will cause damage to the OPC drum. Close the access door should the installation need to be halted for any reason.

- 3 Push the levers up.

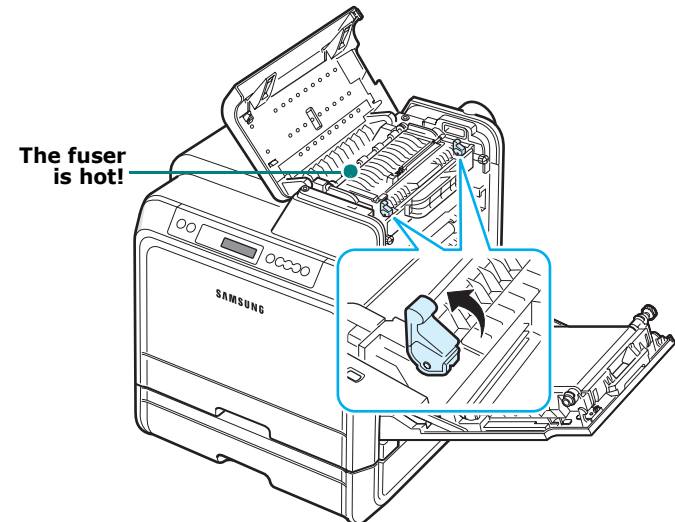

- 4 Open the inner cover using the handle on it and carefully take the jammed paper out of the printer.

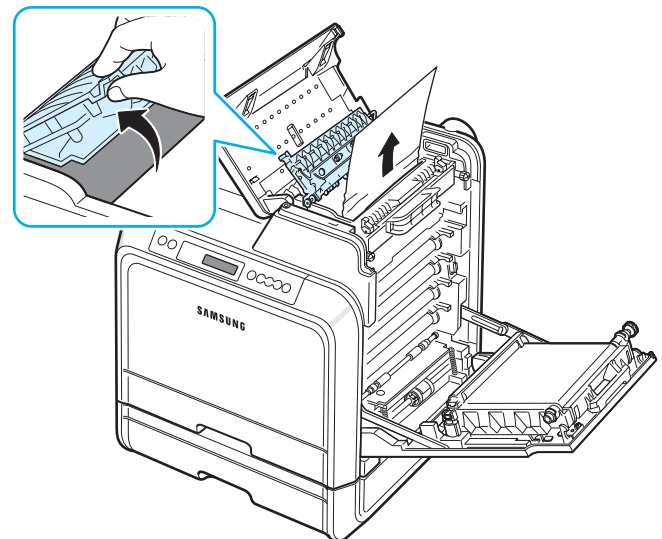

- 5 Close the inner cover and push the levers down. Go to step 14.

If you cannot find the jammed paper, or if there is any resistance removing the paper, stop pulling and close the access door. Go to step 6.

- 6** Open the outer jam cover in Tray2.

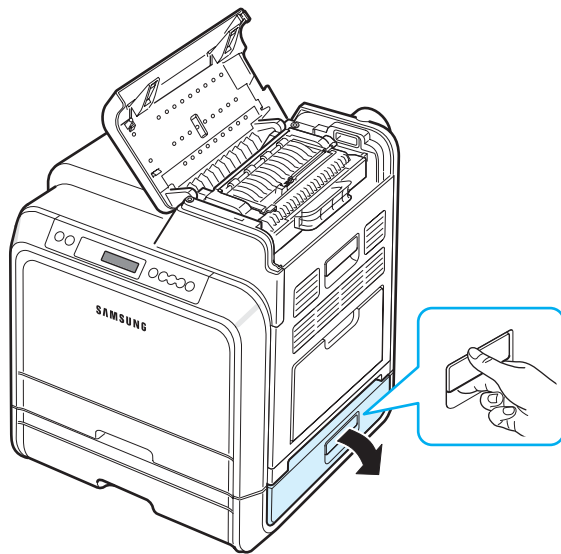

- 7** Open the inner cover of Tray2.

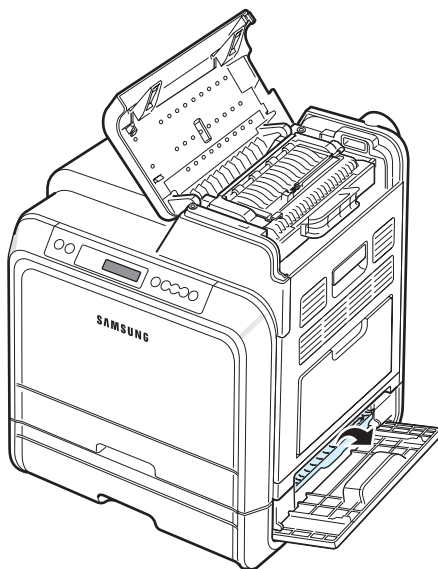

- 8** Pull the jammed paper out in the direction shown. To avoid tearing the paper, pull it out gently and slowly.

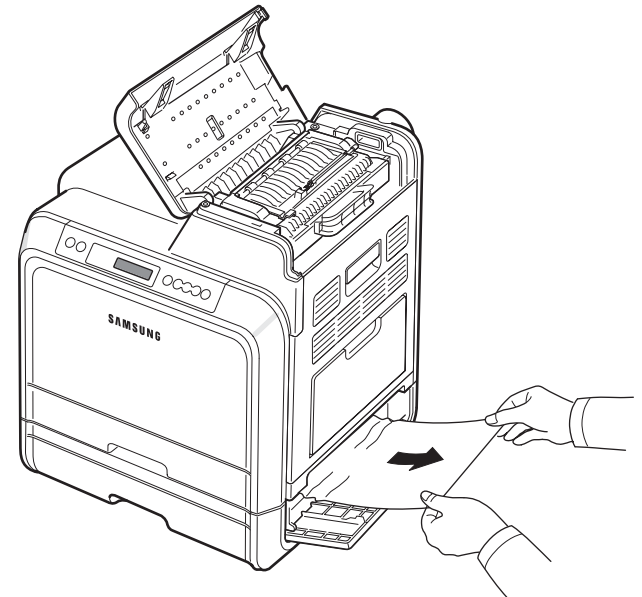

- 9** Close the two jam covers and go to step 13.

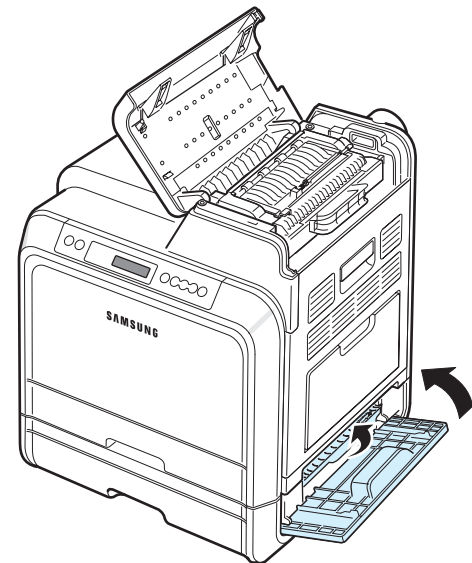

If you cannot find the jammed paper, or if there is any resistance removing the paper, stop pulling and continue to step 10.



- 10** Pull the optional Tray2 open. After you pull it all the way out, lift up the front part of the tray slightly to release the tray from the printer.

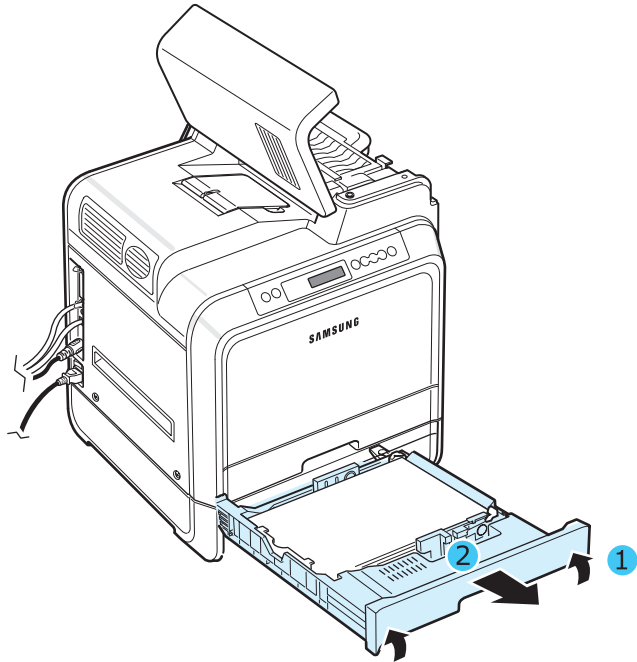

- 11** If you see the jammed paper, remove the paper from the printer by gently pulling it straight out as shown below.

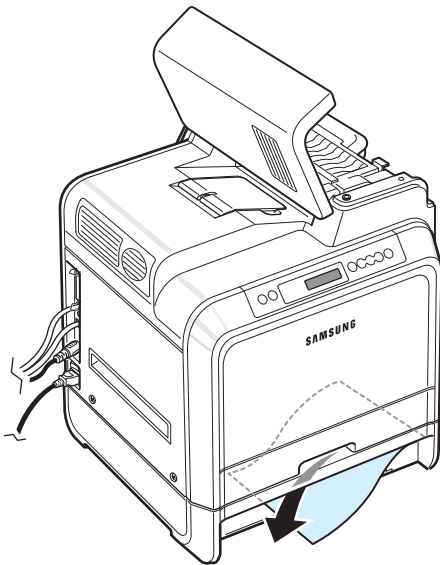

- 12** Slide the tray back into the printer and close the two jam covers.

- 13** Open the access door.

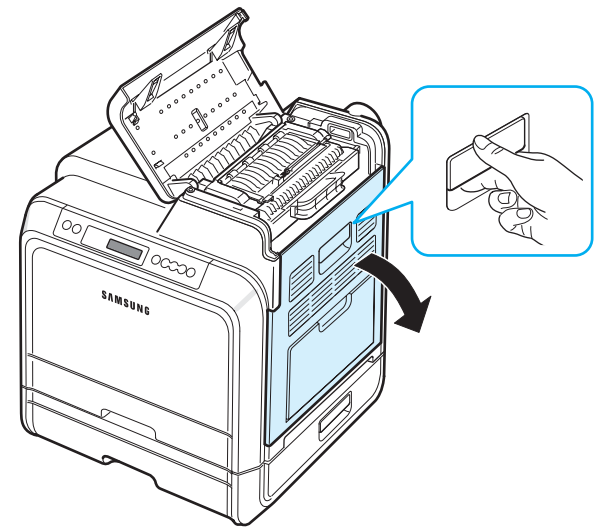

- 14** After making sure that the access door is open. Close the top cover.

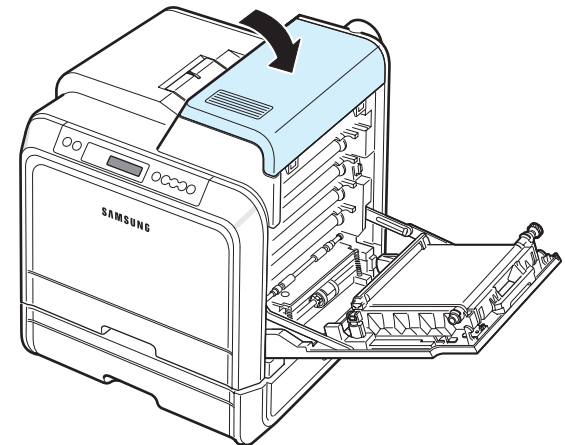

- 15** Close the access door firmly. The printer will resume printing.

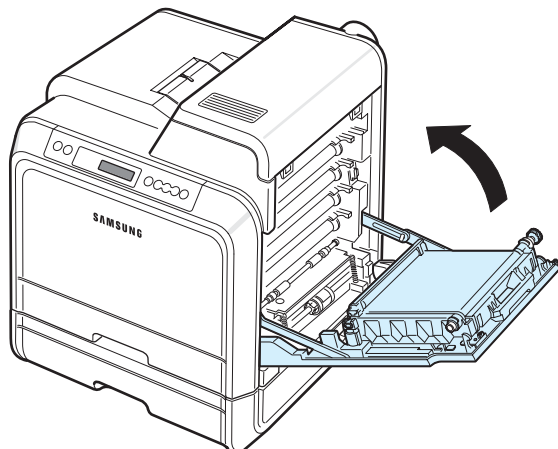

**CAUTION:** If the top cover and access door are not completely closed, the printer will not operate.



## Tips for Avoiding Paper Jams

By selecting the correct paper types, most paper jams can be avoided. If a paper jam occurs, follow the steps outlined in "Clearing Paper Jams" on page 7.4.

- Follow the procedures on page 4.2. Ensure that the adjustable guides are positioned correctly.
- Do not overload the paper tray.
- Do not remove the paper from the tray while printing.
- Flex, fan, and straighten the paper before loading.
- Do not use creased, damp, or highly curled paper.
- Do not mix paper types in a tray.
- Use only recommended print materials. See "Paper Specifications" on page 10.1.
- Ensure that the recommended print side of print materials is facing up in the paper tray and facing down in the Multi-purpose Tray.



## Solving Print Quality Problems

Dirt inside of the printer or improper paper loading may reduce print quality. See the table below to troubleshoot problems.

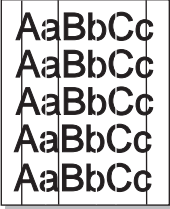
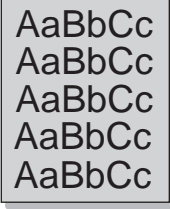
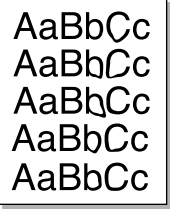
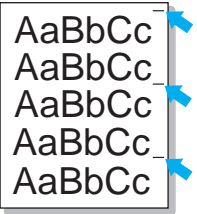
Problem	Solution
<p><b>Light or faded print</b></p> 	<p>If a vertical white streak or faded area appears on the page:</p> <ul style="list-style-type: none"> <li>• The toner supply is low. You may be able to temporarily extend the toner cartridge life. See "Redistributing Toner" on page 6.2. If this does not improve print quality, install a new toner cartridge.</li> <li>• The paper may not meet paper specifications (for example, the paper is too moist or too rough). See "Paper Specifications" on page 10.1.</li> <li>• A combination of faded or smeared defects may indicate that the printer needs cleaning. See page 6.8.</li> </ul>
<p><b>Toner specks</b></p> 	<p>The paper may not meet specifications (for example, the paper is too moist or too rough). See "Paper Specifications" on page 10.1.</p>
<p><b>Dropouts</b></p> 	<p>If generally rounded, faded areas occur randomly on the page:</p> <ul style="list-style-type: none"> <li>• A single sheet of paper may be defective. Try reprinting the job.</li> <li>• The moisture content of the paper is uneven or the paper has moist spots on its surface. Try a different brand of paper. See "Paper Specifications" on page 10.1.</li> <li>• The paper lot is bad. The manufacturing process can cause some areas to reject toner. Try a different kind or brand of paper.</li> <li>• The toner cartridge may be defective. See "Vertical repetitive defects" on the next column.</li> <li>• If these steps do not correct the problems, contact a service representative.</li> </ul>

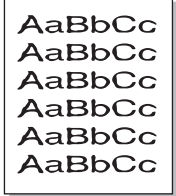
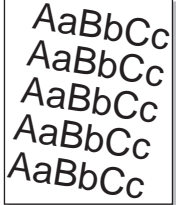
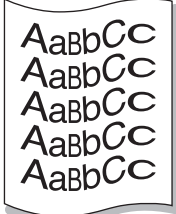
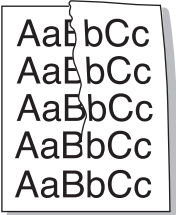
Problem	Solution
<b>Vertical lines</b> 	<p>If black vertical streaks appear on the page:</p> <ul style="list-style-type: none"> <li>A toner cartridge has probably been scratched. Remove the toner cartridge and install a new one. See page 6.4.</li> </ul> <p>If white vertical lines appear on the page:</p> <ul style="list-style-type: none"> <li>Clean the inside of the printer. See "Cleaning the Inside of the Printer" on page 6.8. If you still have the same problems, replace the toner cartridge with a new one. See page 6.4.</li> </ul>
<b>Color or Black background</b> 	<p>If the amount of background shading becomes unacceptable, the procedures below may fix the problem.</p> <ul style="list-style-type: none"> <li>Change to lighter weight paper. See "Paper Specifications" on page 10.1.</li> <li>Check the printer's environment; very dry (low humidity) or high humidity (higher than 80% RH) conditions can increase the amount of background shading.</li> <li>Remove one of the old toner cartridges and install a new one.</li> </ul>
<b>Toner smear</b> 	<ul style="list-style-type: none"> <li>Clean the inside of the printer. See "Cleaning the Inside of the Printer" on page 6.8</li> <li>Check the paper type and quality. See "Paper Specifications" on page 10.1.</li> <li>Remove the paper transfer belt and install a new one. See "Replacing the Paper Transfer Belt" on page 6.5.</li> </ul>
<b>Vertical repetitive defects</b> 	<p>If marks repeatedly appear on the printed side of the page at even intervals:</p> <ul style="list-style-type: none"> <li>Clean the inside of the printer. See "Cleaning the Inside of the Printer" on page 6.8. After cleaning the inside of the printer, if you still have the same problems, install a new toner cartridge of the problem color. See "Replacing Toner Cartridges" on page 6.4.</li> <li>Parts of the printer may have toner on them. If the defects occur on the back of the page, the problem will likely correct itself after a few more pages.</li> <li>The fusing assembly may be damaged. Contact a service representative.</li> </ul>

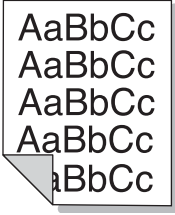
Problem	Solution
<b>Background scatter</b> 	<p>Background scatter results from bits of toner distributed on the printed page.</p> <ul style="list-style-type: none"> <li>The paper may be too damp. Try printing with a different batch of paper. Do not open packages of paper until necessary so that the paper does not absorb too much moisture.</li> <li>If background scatter occurs on an envelope, change the printing layout to avoid printing over areas that have overlapping seams on the reverse side. Printing on seams can cause problems.</li> <li>If background scatter covers the entire surface area of a printed page, adjust the print resolution through your software application or via the printer properties window.</li> </ul>
<b>Misformed characters</b> 	<ul style="list-style-type: none"> <li>If characters are improperly formed and producing hollowed images, the paper stock may be too slick. Try a different paper. See "Paper Specifications" on page 10.1.</li> <li>If characters are improperly formed and producing a wavy effect, the scanner unit may need service. Verify that it also occurs on a demo page. See page 2.8. For service, contact a service representative.</li> </ul>
<b>Page skew</b> 	<ul style="list-style-type: none"> <li>Ensure that the paper is loaded properly.</li> <li>Check the paper type and quality. See "Paper Specifications" on page 10.1.</li> <li>Ensure that the paper or other material is loaded correctly and the guides are not too tight or too loose against the paper stack.</li> </ul>
<b>Curl or wave</b> 	<ul style="list-style-type: none"> <li>Ensure that the paper is loaded properly.</li> <li>Check the paper type and quality. Both high temperature and high humidity can cause paper curl. See "Paper Specifications" on page 10.1.</li> <li>Turn the stack of paper over in the tray. Also try rotating the paper 180° in the tray.</li> </ul>
<b>Wrinkles or creases</b> 	<ul style="list-style-type: none"> <li>Ensure that the paper is loaded properly.</li> <li>Check the paper type and quality. See "Paper Specifications" on page 10.1.</li> <li>Turn the stack of paper over in the paper tray. Also try rotating the paper 180° in the tray.</li> </ul>

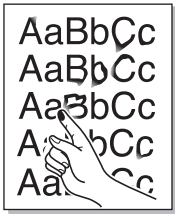
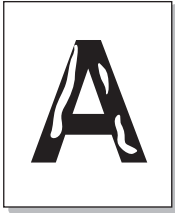
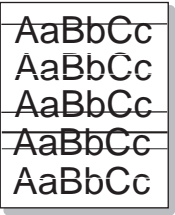
Problem	Solution
<p><b>Back of printouts are dirty</b></p> 	<ul style="list-style-type: none"> <li>• The transfer roller may be dirty. See “Cleaning the Inside of the Printer” on page 6.8.</li> <li>• Check for leaking toner. Clean the inside of the printer.</li> </ul>
<p><b>Solid Color or Black pages</b></p> 	<ul style="list-style-type: none"> <li>• The toner cartridge may not be installed properly. Remove the toner cartridge and reinsert.</li> <li>• The toner cartridge may be defective and need replacing. Install a new toner cartridge.</li> <li>• The printer may require repair. Contact a service representative.</li> </ul>
<p><b>Loose toner</b></p> 	<ul style="list-style-type: none"> <li>• Clean the inside of the printer.</li> <li>• Check the paper type and quality. See “Paper Specifications” on page 10.1.</li> <li>• Install a new toner cartridge. See “Replacing Toner Cartridges” on page 6.4.</li> <li>• If the problem persists, the printer may require repair. Contact a service representative.</li> </ul>
<p><b>Character Voids</b></p> 	<p>Character voids are white areas within characters that should be solid black:</p> <ul style="list-style-type: none"> <li>• You may be printing on the wrong surface of the paper. Remove the paper and turn it over.</li> <li>• The paper may not meet paper specifications. See page 10.1.</li> </ul>
<p><b>Horizontal stripes</b></p> 	<p>If horizontally aligned color or black streaks or smears appear:</p> <ul style="list-style-type: none"> <li>• A toner cartridge may be installed improperly. Remove the toner cartridge and reinsert.</li> <li>• A toner cartridge may be defective. Install a new toner cartridge.</li> <li>• If the problem persists, the printer may require repair. Contact a service representative.</li> </ul>

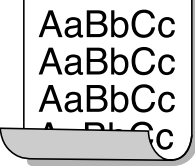
Problem	Solution
<p><b>Curl</b></p> 	<p>If the printed paper is curled or paper does not feed into the printer:</p> <ul style="list-style-type: none"> <li>• Turn the stack of paper over in the paper tray. Also try rotating the paper 180° in the tray.</li> </ul>

## Understanding Display Messages

Messages appear on the SmartPanel program window or the control panel display to indicate the printer’s status or errors. Refer to the tables below to understand the messages’ meanings and correct the problem if necessary. Messages and their meanings are listed in alphabetical order.

**NOTE:** When you call for service, it is very helpful to tell the service representative the display message.

Message	Status	Do this...
Adjusting Registration	<b>Auto color reg</b> is in the process. Please wait.	Till the message is turned to be Ready, please wait up to 120 seconds referring to page 3.5
ADC Not Confirm Error	A problem has occurred in the ADC in the printer.	Contact a service representative.
Cover Open Install Transfer Belt	The top cover or access door is open. Otherwise, the paper transfer belt is not installed in the printer.	Close the top cover or access door firmly. Otherwise, Install the paper transfer belt.
[Color] Toner Empty	The corresponding toner cartridge in your printer is empty, and the printer will stop printing until a new toner cartridge is put into the printer.	Replace the corresponding toner cartridge with a new one. See page 6.4.
Dev. Motor error	A problem has occurred in the development motor of the printer.	Unplug the power cord and plug it in again. If the problem persists, call for service.

Message	Status	Do this...
Engine Fuser Low Heat Error	The temperature in the fuser is abnormally low.	Unplug the power cord and plug it in again. If the problem persists, call for service.
Engine Fuser Over Heat Error	The temperature in the fuser is abnormally high.	Unplug the power cord and plug it in again. If the problem persists, call for service.
Engine Fuser Inverter Error	A problem has occurred in the Fuser in the printer.	Unplug the power cord and plug it in again. If the problem persists, call for service.
Engine LSU Error	A problem has occurred in the LSU (Laser Scanning Unit) in the printer.	Unplug the power cord and plug it in again. If the problem persists, call for service.
Install [Color] Toner	The indicated color toner cartridge is not installed in the printer.	Install the corresponding color toner cartridge.
Install Transfer Belt	The paper transfer belt is not installed in the printer.	Install the paper transfer belt.
Invalid Toner [Color]	An invalid toner cartridge has been installed.	Only install Samsung toner cartridges, designed for your printer. Or install the toner cartridge into each proper cartridge slot. If you have installed an Samsung toner cartridge or into each proper cartridge slot and this error still occurs, contact an authorized service agent.
Invalid Transfer Belt	An invalid paper transfer belt has been installed.	Only install Samsung paper transfer belts, designed for your printer. If you have installed an Samsung paper transfer belt and this error still occurs, contact an authorized service agent.
Jam0 In Tray1 Jam0 In Tray2 Jam0 In MP Tray	A paper jam has occurred in or near the indicated tray.	Remove the jammed paper from the corresponding tray, referring to page 7.4.
Jam In Exit Area	A paper jam has occurred in the paper exit area.	Remove the jammed paper from the printer, referring to page 7.7.
Jam Inside Printer	A paper jam has occurred inside the printer.	Open the access door and remove the jammed paper from the printer, referring to page 7.6.

Message	Status	Do this...
Load [Size] In Tray1 Load [Size] In Tray2 Load [Size] In MP	The paper size specified in the printer properties does not match the paper you are loading.	Load the correct paper in the tray.
Low Density	The amount of the toner which is spread on the paper transfer belt for adjusting auto color registration is very small, so that the printer does not recognize the toner during auto color registration.	Replace the toner cartridge(s) with a new one. See page 6.4. If you still have the same problem, contact a service representative.
Left Fan Error	A problem has occurred in the Left Fan of the printer.	Unplug the power cord and plug it in again. If the problem persists, call for service.
Main Motor Error	A problem has occurred in the development motor of the printer.	Unplug the power cord and plug it in again. If the problem persists, call for service.
Memory Overflow	The printer does not have enough memory to print the current job. An error has occurred in the firmware program of the printer.	The job automatically clears and the printer returns to Standby Mode. Lower the print resolution and try again.
Paper Empty [Size] In Tray1 Paper Empty [Size] In Tray2 Paper Empty [Size] In Mp Paper Empty [Size] In Manual	The paper tray has run out of paper.	Load paper in the paper tray. See page 4.2.
Photo LED error	During auto color registration, the printer does not recognize the photo LED in the paper transfer belt assembly.	Contact a service representative.

Message	Status	Do this...
Press Continue Button	The printer is waiting for the user's action before printing from the Multi-purpose Tray using the manual feed mode.	Load a sheet of print material and press the <b>On Line/ Continue</b> button. You need to press the button for each page.
Ready [Color] Low Toner	The corresponding toner cartridge in your printer is low on toner.	Redistribute the toner in the corresponding toner cartridge, referring to page 6.2.
Ready IP Conflict	The IP address of the printer conflicts with other devices on the network.	Contact your network administrator and choose an address within your subnet which will not conflict with any other devices.
Rear Fan Error	A problem has occurred in the Rear Fan of the printer.	Unplug the power cord and plug it in again. If the problem persists, call for service.
Replace [Color] Toner	The corresponding toner cartridge in your printer is nearly empty. However, the printer continues printing, even though print quality is not optimal. When the '[Color] Toner Empty' message appears, the printer will stop printing.	If necessary, replace the corresponding toner cartridge with a new one. See page 6.4.
Replace Fuser	The life span of the fuser unit has expired and the printer will stop printing until a new fuser unit is placed into the printer.	Replace the fuser unit with a new one. See page 6.7.
Replace Fuser Soon	The life span of the fuser unit will expire soon.	When "Replace Fuser" message appears, the printer will stop printing. Replace the fuser unit.
Replace MP Pick-roller	The life span of the MP pickup roller has expired.	Contact a service representative.
Replace Transfer Belt	The life span of the paper transfer belt has expired and the printer will stop printing until a new paper transfer belt is placed into the printer.	Replace the paper transfer belt with a new one. See page 6.5.

Message	Status	Do this...
Replace Transfer Belt Soon	The life span of the paper transfer belt will expire soon.	When the "Replace Transfer Belt" message appears, the printer will stop printing. Replace the paper transfer belt.
Replace Tray1 Pick-roller	The life span of the Tray1 pickup roller has expired.	Contact a service representative.
Replace Tray2 Pick-roller	The life span of the Tray2 pickup roller has expired.	Contact a service representative.
SMPS Fan Error	A problem has occurred in the SMPS Fan of the printer.	Unplug the power cord and plug it in again. If the problem persists, call for service.
Tray2 Error	The optional Tray2 is not properly installed or connected to the printer.	After turn the printer off and then back on, reinstall the optional Tray2. If the message persists, contact a service representative.
Tray2 Jam Cover Open	The optional Tray2 jam cover is open.	Close the Tray2 cover firmly.

## Common Windows Problems

Problem	Possible Cause and Solution
"File in Use" message appears during installation.	Exit all software applications. Remove all software from the StartUp Group, then restart Windows. Reinstall the printer driver.
"Error Writing to LPTx" message appears.	<ul style="list-style-type: none"> <li>• Ensure that all cables are connected correctly and the printer is on.</li> <li>• If bi-directional communication is not turned on in the driver, it will also cause this message.</li> </ul>
"General Protection Fault", "Exception OE", "Spool32", or "Illegal Operation" messages appear.	Close all other applications, reboot Windows and try printing again.
"Fail To Print", "A printer timeout error occurred." messages appear.	These messages may appear during printing. Just keep waiting until the printer finishes printing. If the message appears in standby mode or after printing has been completed, check the connection and/or whether an error has occurred.

**NOTE:** Refer to the Microsoft Windows 98SE/Me/NT 4.0/2000/2003/XP User's Guide that came with your PC for further information on Windows error messages.

## Common Macintosh Problems

Problem	Possible Cause and Solution
The printer does not print a document from Acrobat Reader.	You should change the Print Method option to <b>Print as Image</b> when you print from Acrobat Reader.
The document has printed, but the print job has not disappeared from the spooler in Mac OS 10.3.2.	Update your Mac OS to OS 10.3.3 or higher.
The printer does not print a document from Illustrator on IPP printing.	You should change the data type option to binary of Adobe Illustrator print menu. Or you can use Appletalk printing.

## Common PS Errors

The following situations are PS language specific and may occur when several printer languages are being used.

**NOTE:** To receive a printed or screen displayed message when PS errors occur, open the Print Options window and click the desired selection next to the PostScript errors section.

Message	Status	Do this...
PostScript file can not be printed.	The PostScript driver may not be installed correctly. Or a problem has occurred in the PostScript DIMM.	<ul style="list-style-type: none"> <li>• Reinstall the PS driver, referring to <b>Software Section</b>.</li> <li>• Print a configuration page and verify that the PS version is available for printing.</li> <li>• If the problem persists, contact a service representative.</li> </ul>
"This job contains binary data..." message appears.	The pure binary data option is not supported by the PostScript driver.	Open the Properties of the PostScript driver, click on <b>PostScript</b> , and click on <b>Advanced</b> . The pure binary data option is not supported. Choose another.
A PS error page prints.	Print job may not be PS.	Make sure that the print job is a PS job. Check to see whether the software application expected a setup or PS header file to be sent to the printer.
The optional Tray2 is not selected in the driver.	The printer driver has not been configured to recognize the optional Tray2.	Open the PostScript driver properties and set the <b>Option Tray</b> item of the <b>Device</b> option to <b>Installed</b> .
In Windows NT 4.0/2000/XP, when you select <b>Black &amp; White</b> in the <b>Color</b> option of the paper/quality properties, the document prints in color instead of in the black and white.	In some programs, such as Acrobat Reader, Adobe Photoshop, and CorelDraw, the Color option may not be available.	Open the PS driver properties and click the <b>Advanced</b> tab. Set the <b>Color Mode</b> under the <b>Printer Features</b> option to <b>Gray</b> .
When print a document in Macintosh with Acrobat Reader 6.0 or higher, colors print incorrectly.	The resolution setting in the printer driver may not be matched with that in Acrobat Reader.	Make sure that the resolution setting in your printer driver matches that in Acrobat Reader.

Message	Status	Do this...
"Limit Check Error" message appears.	The print job was too complex.	You might need to reduce the complexity of the page or install more memory.

## Common Linux Problems

Problem	Possible Cause and Solution
I can't change settings in the configuration tool.	You need to have administrator privileges to be able to change global settings.
I am using the KDE desktop but the configuration tool and LLPR won't start.	You may not have the GTK libraries installed. These usually come with most Linux distributions, but you may have to install them manually. Refer to your distribution's installation manual for more details about installing additional packages.
I just installed this package but can't find entries in the KDE/Gnome menus.	Some versions of the KDE or GNOME desktop environments may require that you restart your session for the changes to take effect.
I get a "Some options are not selected" error message while editing the printer settings.	Some printers have conflicting settings, meaning that some settings for two options can't be selected at the same time. When you change a setting and the Printer Package detects such a conflict, the conflicting option is changed to a "No Choice" value. You have to choose an option that does not conflict before being able to submit the changes.
I can't make a printer the system default.	In some conditions, it may not be possible to change the default queue. This happens with some variants of LPRng, especially on recent RedHat systems that use the "printconf" database of queues.  When using printconf, the <b>/etc/printcap</b> file is automatically refreshed from the database of printers managed by the system (usually through the "printtool" command), and the queues in <b>/etc/printcap.local</b> are appended to the resulting file. The default queue in LPRng is defined as the first queue in <b>/etc/printcap</b> , and therefore it is not possible for the Linux Printer Package to change the default when some queues have otherwise been defined using printtool.  LPD systems identify the default queue as the one named "lp". Thus, if there is already a queue by this name, and if it doesn't have an alias, then you won't be able to change the default. To work around this, you can either delete the queue or rename it by manually editing the <b>/etc/printcap</b> file.

Problem	Possible Cause and Solution
The N-up setting does not work correctly for some of my documents.	The N-up feature is achieved through post-processing of the PostScript data that is sent to the printing system. However, such post-processing can only be adequately achieved if the PostScript data conforms to the Adobe Document Structuring Conventions. Problems may arise when using N-up and other features that rely on post-processing if the document being printed isn't compliant.
I am using BSD lpr (Slackware, Debian, older distributions) and some options chosen in LLPR don't seem to take effect.	Legacy BSD lpr systems have a hard limitation on the length of the option string that can be passed to the printing system. As such, if you selected a number of different options, you may have exceeded the length of the options and some of your choices won't be passed to the programs responsible for implementing them. Try to select fewer options that deviate from the defaults, to save on memory usage.
I am trying to print a document in Landscape mode, but it prints rotated and cropped.	Most Unix applications that offer a Landscape orientation option in their printing options will generate correct PostScript code that should be printed as is. In that case, you need to make sure that you leave the LLPR option set to its default Portrait setting, to avoid unwanted rotations of the page that would result in cropped output.
Some pages come out all white (nothing is printed), and I am using CUPS.	If the data being sent is in Encapsulated PostScript (EPS) format, some earlier versions of CUPS (1.1.10 and before) have a bug preventing them from being processed correctly. When going through LLPR to print, the Printer Package will work around this issue by converting the data to regular PostScript. However, if your application bypasses LLPR and feeds EPS data to CUPS, the document may not print correctly.
I can't print to an SMB (Windows) printer.	To be able to configure and use SMB-shared printers (such as printers shared on a Windows printer), you need to have a correct installation of the SAMBA package that enables that feature. The "smbclient" command should be available and usable on your system.
My application seems to be frozen while LLPR is running.	Most Unix applications will expect a command like the regular "lpr" command to be non-interactive and thus return immediately. Since LLPR is waiting for user input before passing the job on to the print spooler, very often the application will wait for the process to return, and thus will appear to be frozen (its windows won't refresh). This is normal and the application should resume functioning correctly after the user exits LLPR.



Problem	Possible Cause and Solution
How do I specify the IP address of my SMB server?	It can be specified in the "Add Printer" dialogue of the configuration tool, if you don't use the CUPS printing system. Unfortunately, CUPS currently doesn't allow you to specify the IP address of SMB printers, so you will have to be able to browse the resource with SAMBA in order to be able to print.
Some documents come out as white pages when printing.	Some versions of CUPS, especially those shipped with Mandrake Linux before the 8.1 release, have some known bugs when processing PostScript output from some applications. Try upgrading to the latest version of CUPS (at least 1.1.14). Some RPM packages for the most popular distributions are provided as a convenience with this Linux Printing Package.
I have CUPS and some options (such as N-up) seem to be always enabled even though I don't choose them in LLPR.	There may be some local options defined in your <code>~/lpoptions</code> file, which are manipulated by the <code>lpoptions</code> command. These options are always used if not overridden by LLPR settings. To get rid of all options for a printer, run the following command, replacing "printer" with the name of the queue: <code>lpoptions -x printer</code>
I configured a printer to print to a file, but I get "Permission denied" errors.	Most printing systems will not run as the super-user but as a special user (usually "lp"). Therefore, make sure that the file you have chosen to print to is accessible to the user owning the spooler daemon.
On my PCL (or GDI) printer, I sometimes get error messages printing instead of my document.	Unfortunately, some Unix applications may generate non-compliant PostScript output that may not be supported by Ghostscript, or even the printer itself in PostScript mode. You can try to capture the output to a file and view the results with Ghostscript ( <code>gv</code> or <code>ghostview</code> will allow you to do so interactively) and see if you get error messages. However, since the application is probably at fault, contact your software vendor to inform them of the issue.
Some color images come out all black.	This is a known bug in Ghostscript (until GNU Ghostscript version 7.05) when the base color space of the document is indexed color space and it is converted through CIE color space. Because Postscript uses CIE color space for Color Matching System, you should upgrade Ghostscript on your system to at least GNU Ghostscript version 7.06 or later. You can find recent Ghostscript versions at <a href="http://www.ghostscript.com">www.ghostscript.com</a> .

# 8 Using Your Printer on a Network (CLP-650N only)

If you work in a networked environment, the printer can be shared by other users on the network.

This chapter includes:

- **About Sharing the Printer on a Network**
- **Setting Up a Network-Connected Printer**

## About Sharing the Printer on a Network

If you work in a networked environment, you can connect your printer to the network.

### Locally-Shared Printer

You can connect the printer directly to a selected computer, which is called the “host computer” on the network. The printer can then be shared by other users on the network through a Windows 98SE/Me/XP/NT 4.0/2000/2003 network printer connection.

For details about sharing the printer locally, see the **Software Section**.

### Wired Network-connected Printer

The CLP-650N printer has a built-in network interface. For more information about connecting your printer to a network, see 2.8.

### Printing Across a Network

Whether the printer is locally connected or network-connected, you need to install the **Samsung CLP-650 Series** printer software on each computer that prints documents using the printer.

## Setting Up a Network-Connected Printer

You have to set up the network protocols on the printer to use it as your network printer. Setting protocols can be accomplished by using the supplied network program. Please refer to the **Network Printer User’s Guide**.

You can configure the basic network parameters through the printer’s control panel. Use the printer control panel to do the following:

- Enable or disable network protocols (IPX/SPX)
- Configure TCP/IP
- Configure IPX frame types

## Configuring Network Parameters on the Control Panel

### Supported Operating Systems

**NOTE:** The operating systems supported by the network card may be different than the operating systems supported by the printer. The following table shows the network environments supported by the printer.

Item	Requirements
Network Interface	10/100 Base-TX (standard)
Network Operating System	<ul style="list-style-type: none"><li>• Novell NetWare 4.x, 5.x, 6.x</li><li>• Windows 98SE/Me/NT 4.0/2000/2003/XP</li><li>• Various Linux OS</li><li>• Macintosh OS 8.6 ~ 9.2/10.1 ~ 10.4.</li></ul>
Network Protocols	<ul style="list-style-type: none"><li>• Netware IPX/SPX</li><li>• TCP/IP, DLC/LLC on Windows</li></ul>
Dynamic Addressing Server	DHCP, BOOTP

- IPX/SPX: Internet Packet eXchange/Sequenced Packet eXchange
- TCP/IP: Transmission Control Protocol/Internet Protocol
- DLC/LLC: Data Link Control/Logical Link Control
- DHCP: Dynamic Host Configuration Protocol
- BOOTP: Bootstrap Protocol

## Printing a Network Configuration Page

The Network Configuration page shows how the network interface card on your printer is configured. The default settings which are suitable for most applications are enabled.

- 1 In ready mode, press the **Menu** button (⌘) until you see "Network" on the bottom line of the display.
- 2 Press the **Enter** button (⌘) to access the menu.
- 3 Press the scroll button (⏪ or ⏩) until "Print Net CFG" displays on the bottom line.
- 4 Press the **Enter** button (⌘).

The Network Configuration page prints out.

## Setting Network Protocols

When you first install the printer, all supported network protocols are enabled. If a network protocol is enabled, the printer may actively transmit on the network even when the protocol is not in use. This may increase network traffic slightly. To eliminate unnecessary traffic, you can disable unused protocols.

- 1 In ready mode, press the **Menu** button (⌘) until you see "Network" on the bottom line of the display. Press the **Enter** button (⌘) to access the menu.
- 2 Press the **Enter** button (⌘) when "Config Network" displays on the bottom line.
- 3 Press the scroll button (⏪ or ⏩) until "Yes" displays, and press the **Enter** button (⌘). Then press the **Upper Level** button (⏴).
- 4 Press the scroll button (⏪ or ⏩) until you see the desired protocol on the bottom line.

You can choose between "Config TCP" and "Netware".

- 5 Press the **Enter** button (⌘).
- 6 Press the scroll button (⏪ or ⏩) to change the setting.  
If you selected "Config TCP", change the setting to "No" (disable) or "Yes" (enable).  
If you selected "Netware", change the setting to "Off" (disable) or "On" (enable).
- 7 Press the **Enter** button (⌘) to save the selection.
- 8 Press the **On Line/Continue** button (⏴) to return to ready mode.

## Configuring TCP/IP

Your printer can be set up on a variety of TCP/IP networks. There are several ways in which your printer can be assigned a TCP/IP address, depending on your network.

- Static Addressing: TCP/IP address is assigned manually by the system administrator.
- Dynamic Addressing BOOTP/DHCP (default): TCP/IP address is assigned automatically by the server.

### Static Addressing

To enter the TCP/IP address from your printer's control panel, take the following steps:

- 1 In ready mode, press the **Menu** button (⌘) until you see "Network" on the bottom line of the display. Press the **Enter** button (⌘) to access the menu.
- 2 Press the **Enter** button (⌘) when "Config Network" displays on the bottom line.
- 3 Press the scroll button (⏪ or ⏩) until "Yes" displays, and press the **Enter** button (⌘).
- 4 Press the **Upper Level** button (⏴), then use the scroll button (⏩).
- 5 Press the **Enter** button (⌘) when "Config TCP" displays.
- 6 Press the scroll button (⏪ or ⏩) until "Yes" displays, and press the **Enter** button (⌘).
- 7 Press the **Upper Level** button (⏴), then use the scroll button (⏩).
- 8 Press the **Enter** button (⌘) when "IP Get Method" displays.
- 9 Press the scroll button (⏪ or ⏩) until "Static" displays, and press the **Enter** button (⌘).
- 10 Press the **Upper Level** button (⏴), then use the scroll button (⏩).
- 11 Press the **Enter** button (⌘) when "IP Address" displays.

An IP address consists of 4 bytes.

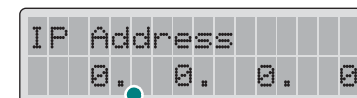

Enter a number between 0 and 255 for each byte.

- 12 Press the scroll button (⏪ or ⏩) to enter a number between 0 and 255 and press the **Enter** button (⌘).

- 13 Repeat step 12 to complete the address from the 1st byte to the 4th byte.
- 14 To select other parameters, such as the Subnet Mask or Gateway, press the scroll button (◀ or ▶). Press the **Enter** button (\*).
- 15 Repeat steps 12 through 13 to configure the other TCP/IP parameters.
- 16 Press the **On Line/Continue** button (↔) to return to ready mode.

### Dynamic Addressing (BOOTP/DHCP)

To assign the TCP/IP address automatically by the server, take the following steps:

- 1 In ready mode, press the **Menu** button (☰) until you see "Network" on the bottom line of the display. Press the **Enter** button (\*) to access the menu.
- 2 Press the **Enter** button (\*) when "Config Network" displays on the bottom line.
- 3 Press the scroll button (◀ or ▶) until "Yes" displays, and press the **Enter** button (\*).
- 4 Press the **Upper Level** button (⤴), then use the scroll button (▶).
- 5 Press the **Enter** button (\*) when "Config TCP" displays.
- 6 Press the scroll button (◀ or ▶) until "Yes" displays, and press the **Enter** button (\*).
- 7 Press the **Upper Level** button (⤴), then use the scroll button (▶).
- 8 Press the **Enter** button (\*) when "IP Get Method" displays.
- 9 Press the scroll button (◀ or ▶) until "DHCP" displays, and press the **Enter** button (\*).
- 10 To assign the address from the BOOTP server, press the **Enter** button (\*) when "BOOTP" displays.
- 11 Press the **On Line/Continue** button (↔) to return to ready mode.

### Configuring IPX Frame Types

On IPX/SPX protocol networks (for example, Novell NetWare), the format of the network communication frames must be specified for the printer. In most cases, you can keep the 'Auto' default setting. However, you can manually set the frame type format, if required.

- **Auto** (default): Automatically senses and limits the frame type to the first one detected.
- **EN\_8022**: Limits the frame type to IPX over IEEE 802.2 with IEEE 802.3 frames. All others will be discarded.
- **EN\_8023**: Limits the frame type to IPX over IEEE 802.3 frames. All others will be discarded.
- **EN\_II**: Limits the frame type to IPX over Ethernet Frames. All others will be discarded.
- **EN\_SNAP**: Limits the frame type to IPX over SNAP with IEEE 802.3 frames. All others will be discarded.

Note that the IPX/SPX protocol must be enabled in the **Netware** menu before you can configure frame types. See "Setting Network Protocols" on page 8.2.

Take the following steps to change the frame type format:

- 1 In ready mode, press the **Menu** button (☰) until you see "Network" on the bottom line of the display. Press the **Enter** button (\*) to access the menu.
- 2 Press the **Enter** button (\*) when "Config Network" displays on the bottom line.
- 3 Press the scroll button (◀ or ▶) until "Yes" displays on the bottom line. Press the **Enter** button (\*).
- 4 Press the **Upper Level** button (⤴).
- 5 Press the scroll button (◀ or ▶) until "Netware" displays on the bottom line. Press the **Enter** button (\*).
- 6 Press the scroll button (◀ or ▶) until "On" displays on the bottom line. Press the **Enter** button (\*).
- 7 Press the **Upper Level** button (⤴), then use the scroll button (▶).
- 8 Press the **Enter** button (\*) when "Config Netware" displays.
- 9 Press the scroll button (◀ or ▶) until "Yes" displays on the bottom line. Press the **Enter** button (\*).
- 10 Press the **Upper Level** button (⤴), then use the scroll button (▶).
- 11 Press the **Enter** button (\*) when "IPX Frame Type" displays.

**12** Press the scroll button (⏪ or ⏩) until you see the desired frame type and press the **Enter** button (⌘).

**13** Press the **On Line/Continue** button (⏪) to return to ready mode.

### Restoring the Network Configuration

You can return the network configuration to its default settings.

**1** In ready mode, press the **Menu** button (⌘) until you see "Network" on the bottom line of the display.

**2** Press the **Enter** button (⌘) to access the menu.

**3** Press the scroll button (⏪ or ⏩) until "Default Set" displays on the bottom line. Press the **Enter** button (⌘).

**4** Press the **Enter** button (⌘) to confirm the selection.

**5** Reboot the network interface card.

### Rebooting the Network Interface Card

If you configured the "Netware" or "Config WLAN" menu option, the printer will not recognize your change.

In this case, you can simply reboot the network interface card without turning your printer off and back on.

**1** In ready mode, press the **Menu** button (⌘) until you see "Network" on the bottom line of the display.

**2** Press the **Enter** button (⌘) to access the menu.

**3** Press the scroll button (⏪ or ⏩) until "Reset Network" displays on the bottom line. Press the **Enter** button (⌘).

**4** Press the **Enter** button (⌘).

The printer reboots the network interface card.

# 9 Installing Printer Options

Your printer is a full-featured laser printer that has been optimized to meet most of your printing needs. Recognizing that each user may have different requirements, however, Samsung makes several options available to enhance the printer's capabilities.

This chapter includes:

- **Precautions When Installing Printer Options**
- **Installing an Optional Paper Tray**
- **Installing a memory DIMM**

## Precautions When Installing Printer Options

### **DISCONNECT THE POWER CORD:**

Never remove the printer control board while the printer is plugged in.

To avoid the possibility of an electrical shock, always disconnect the power cord when installing or removing ANY internal or external printer option.

### **DISCHARGE STATIC ELECTRICITY:**

The control board and internal printer option, Network Interface Cards, are sensitive to static electricity. Before installing or removing an internal option, discharge static electricity from your body by touching something metal, such as the metal back plate on any device plugged into a grounded power source. If you walk round before finishing installation, discharge any static electricity once again.

## Installing an Optional Paper Tray

You can increase the paper handling capacity of your printer by installing an optional Tray2. This tray holds 500 sheets of paper.

- 1 Remove the packing tape and the packing material inside of the tray.

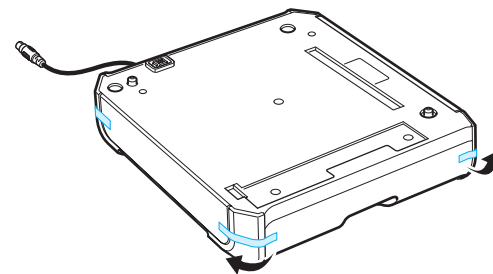

- 2 Find the location of the connector and the optional tray positioners.

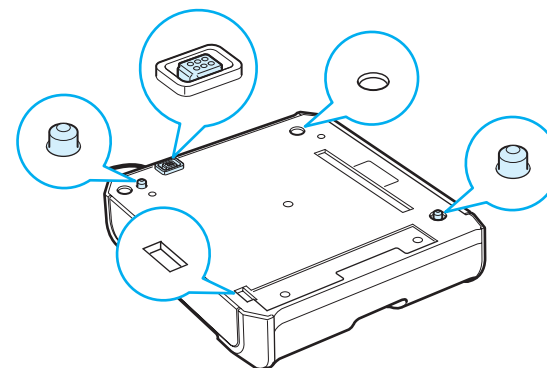

- 3 Place the printer over the tray, aligning the feet on the printer with the positioners on the optional tray.

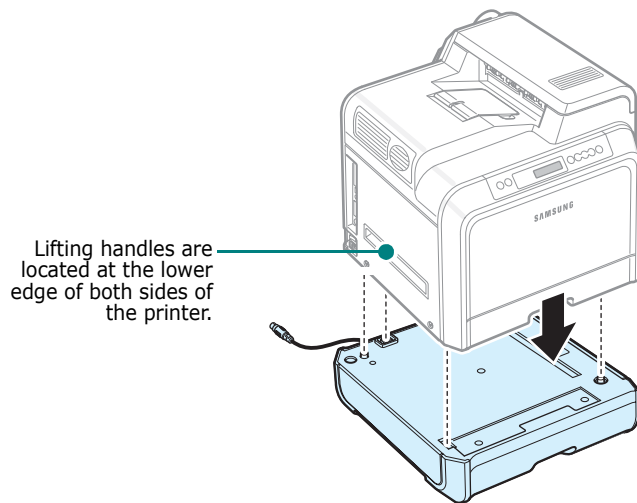

**CAUTION:** This printer weighs 29.1kg including the toner cartridges and the cassette. Use safe lifting and handling techniques. If you need to move the printer, it should be moved by two people. Use the lifting handles as shown in the diagram (see page 1.3). Back injury could be caused if a single person attempts to lift the printer.

- 4 Plug the tray's interface cable into the connector on the left rear of the printer.

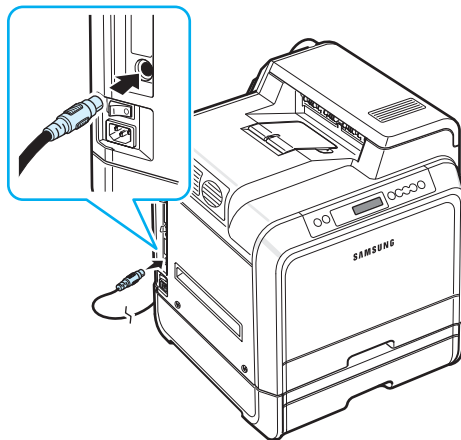

After installing Tray2, you must set the tray as installed in the printer properties window.

- 1 Click the Windows **Start** menu.
- 2 For Windows 98SE/Me/NT 4.0/2000, select **Settings** and then **Printers**.  
For Windows XP/2003, select **Printers and Faxes**.
- 3 Select the **Samsung CLP-650 Series** printer icon.
- 4 Right-click on the printer icon and select **Properties**.

- 5 Click the **Printer** tab, and select **Tray2** from the **Optional Tray** drop-down list.

- 6 Click **OK**.

## Installing a memory DIMM

Your printer has a dual in-line memory module (DIMM) slot. Use this DIMM slot to install more memory for the printer.

**NOTE:** Your printer has 256 MB of memory which can be expanded to 512 MB. To expand the memory, purchase the Samsung standard SODIMM by contacting your Samsung dealer. The part numbers is CLP-MEM102 (256 MB DDR).

- 1 Turn the printer off and unplug all cables from the printer.
- 2 Grasp the **control board cover** and remove it.

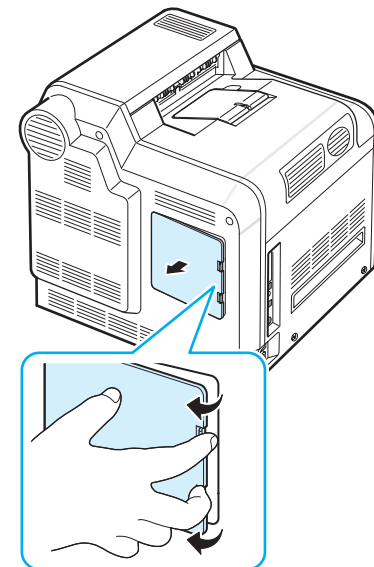

- 3 Remove the screw on the metal plate and then the metal plate by pushing it up.

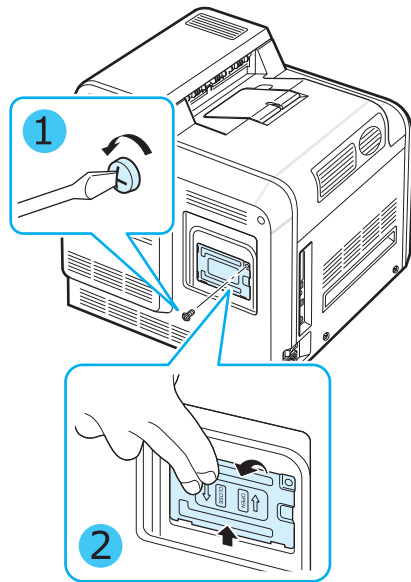

- 4 Take out a new memory DIMM from its antistatic package.
- 5 Locate the memory DIMM slot, the lower slot, and align the notch on the memory DIMM with the groove at the memory DIMM slot by holding the memory DIMM edges.

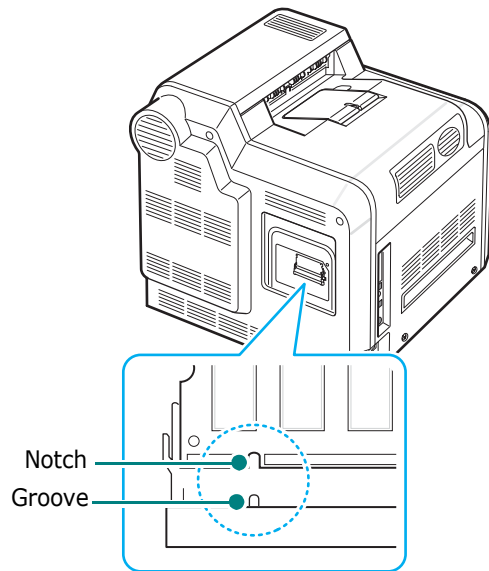

- 6 Push the DIMM into the lower slot until it snaps into place.

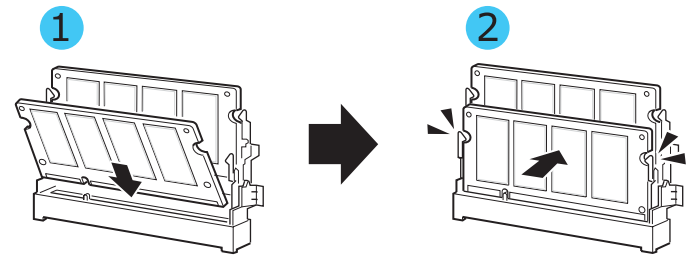

- 7 Replace the metal plate and insert the screw into the hole, as shown below. Carefully tighten it.

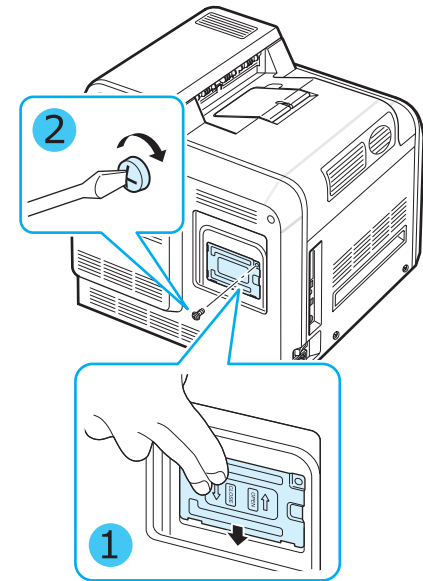

- 8 Replace the **control board cover**.

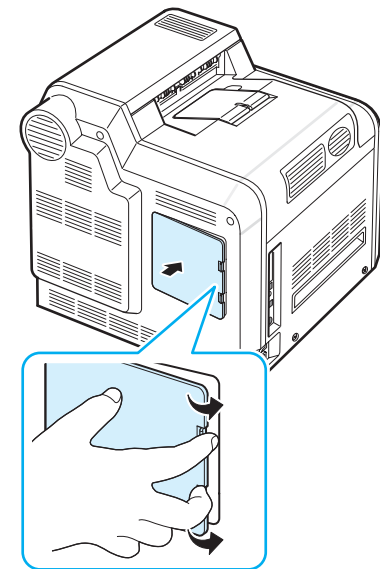

- 9 Reconnect the **power cord** and printer cable, and turn the printer on.



## Activating the added memory in the PS printer properties

After installing the memory DIMM, you need to select it in the printer properties of the PostScript printer driver so that you can use it:

- 1** Make sure that the PostScript printer driver is installed on your computer. For details about installing the PS printer driver, see the **Software Section**.
- 2** Click the Windows **Start** menu.
- 3** For Windows 98/Me/NT 4.0/2000, select **Settings** and then **Printers**.  
For Windows XP, select **Printers and Faxes**.
- 4** Select the **Samsung CLP-650 Series PS** printer.
- 5** Click the right mouse button on the machine icon and select **Properties**.
- 6** For Windows 98/Me, select **Device Options**.  
For Windows NT 4.0/2000/XP, select **Device Settings**.
- 7** Select the memory DIMM you installed from **Printer Memory** in the **Installable Option** section.  
For Windows 98, select **Installable Option** → **VMOption** → **change setting for:VMOption** → **change memory**.
- 8** Click **OK**.

# 10 Specifications

This chapter includes:

- **Printer Specifications**
- **Paper Specifications**

## Printer Specifications

Item	Specifications and Description
Print Speed*	Black and color: Up to 20 PPM in A4 (21 PPM in Letter)
Resolution	Up to 2400 x 600 dpi
Warm-up Time	Less than 30 seconds
First Print out Time	16 seconds (from Ready)
Power Rating	110 ~ 127VAC, 9A (USA, Canada), 50/60Hz 220 ~ 240VAC, 4.5A (Others), 50/60Hz
Power Consumption	450 W average during operation / Less than 35 W in power save mode
Noise Level**	Less than 52 dBA (printing) Less than 35 dBA (Standby printing)
Consumables Life	Black/Yellow/Magenta/Cyan Toner Cartridge: Approx. 4,000 A4/Letter pages at 5% Coverage Paper Transfer Belt: Approx. 35,000 black and color pages*** Fuser: Approx. 50,000 black and color pages****
Duty Cycle	Monthly: Up to 35,000 pages
Weight	29.1kg (including consumables)(64 lbs)
Package Weight	Paper: 3.5Kg, Plastic: 900g
External Dimensions (W x D x H)	465 (W) x 465 (D) x 445 (H) mm (18.3 x 18.3 x 17.5 in.)
Operating Environment	Temperature: 10 ~ 32.5°C / 50 ~ 90°F Humidity: 20 ~ 80% RH
Printer Language	PostScript 3, PCL 6C, SPL-C (Samsung Printer Language Color)
Memory	256 MB
Fonts	45 scalable and 1 bitmap PCL and 136 PS
Interface	CLP-650: USB 2.0, IEEE 1284 Parallel CLP-650N: USB 2.0, IEEE 1284 Parallel, Ethernet 10/100 Base TX

Item	Specifications and Description
Printer Drivers****	Samsung proprietary driver: Windows 98SE/Me/NT4.0/2000/XP/2003 PostScript driver: Windows 98SE/Me/NT4.0/2000/XP/2003, Various Linux OS, Mac OS 8.6 ~ 9.2/10.1 ~ 10.4.

- \* Print speed will be affected by operating system used, computing performance, application software, connecting method, media type, media size, and job complexity.  
\*\* Sound Pressure Level, ISO7779  
\*\*\* May be affected by operating environment, printing interval, media type, and media size.  
\*\*\*\* Please visit [www.samsungprinter.com](http://www.samsungprinter.com) to download the latest software version.

## Paper Specifications

### Overview

Your printer accepts a variety of print materials, such as cut-sheet paper (including up to 100% recycled fiber content paper), envelopes, labels, and custom-size paper. Properties, such as weight, composition, grain, and moisture content, are important factors affecting the printer's performance and the output quality. Paper that does not meet the guidelines outlined in this User's Guide can cause the following problems:

- Poor print quality
- Increased paper jams
- Premature wear on the printer.

### NOTES:

- Some paper may meet all of the guidelines in this guide and still not produce satisfactory results. This may be the result of improper handling, unacceptable temperature and humidity levels, or other variables over which Samsung has no control.
- Before purchasing large quantities of paper, ensure that the paper meets the requirements specified in this User's Guide.



**CAUTION:** Using paper that does not meet these specifications may cause problems, requiring repairs. These repairs are not covered by the Samsung warranty or service agreements.

## Supported Sizes of Paper

Tray1/ Tray2	Dimensions*	Weight	Capacity**
Letter	8.5 x 11in. (216 x 279mm)	75 to 90g/m <sup>2</sup> bond (20 to 24lb) for single-sided printing	<ul style="list-style-type: none"> <li>• 250 sheets of 75g/m<sup>2</sup> bond paper for Tray1</li> <li>• 500 sheets of 75g/m<sup>2</sup> bond paper for Tray2</li> </ul>
A4	8.27 x 11.7in. (210 x 297mm)		

Multi-purpose Tray	Dimensions*	Weight	Capacity**
Minimum Size (custom)	3.5 x 5.5in. (90 x 140mm)	75 to 163g/m <sup>2</sup> bond (20 to 43lb)	100 sheets of 75g/m <sup>2</sup> bond paper
Maximum Size (custom)	8.5 x 14in. (216 x 356mm)		
Labels***	Same minimum and maximum paper sizes as listed above.	Thickness: 0.10 x 0.14 mm (0.0039 x 0.0055in.)	10 typical
Envelopes		75 to 105g/m <sup>2</sup> (20to 27lb)	up to 10

\* The printer supports a wide range of media sizes.

\*\* Capacity may vary depending on media weight and thickness, and environment.

\*\*\* Smoothness: 100 to 250 (Sheffield)

**NOTE:** You may experience jams when using print materials with a length of less than 140mm (5.5in.). For optimum performance, ensure that you are storing and handling the paper correctly. Please refer to "Printer and Paper Storage Environment" on page 10.3.

## Guidelines for Using Paper

For the best result, use conventional 75g/m<sup>2</sup> (20lb) paper. Ensure that the paper is of good quality, and free of cuts, nicks, tears, spots, loose particles, dust, wrinkles, voids, and curled or bent edges.

If you are unsure of what type of paper you are loading, such as bond or recycled paper, check the label on the package.

The following problems may cause print quality deviations, jamming or even damage to the printer.

Symptom	Problem with Paper	Solution
Poor print quality or toner adhesion, problems with feeding	Too moist, too rough, too smooth, or embossed; faulty paper lot	Try another kind of paper, between 100 ~ 250 Sheffield, 4 ~ 5% moisture content.
Dropout, jamming, curl	Stored improperly	Store paper flat in its moisture-proof wrapping.
Increased gray background shading/printer wear	Too heavy	Use lighter paper.
Excessive curl problems with feeding	Too moist, wrong grain direction, or short-grain construction	Use long-grain paper.
Jamming, damage to printer	Cutouts or perforations	Do not use paper with cutouts or perforations.
Problems with feeding	Ragged edges	Use good quality paper.

### NOTES:

- Do not use letterhead paper printed with low-temperature inks, such as those used in some types of thermography.
- Do not use raised or embossed letterhead.
- The printer uses heat and pressure to fuse toner to the paper. Ensure that any colored paper or preprinted forms use inks that are compatible with this fusing temperature (180°C or 356°F for 0.1 second).

## Paper Specifications

Category	Specifications
Acid Content	5.5 ~ 8.0pH
Caliper	0.094 ~ 0.18mm (3.0 ~ 7.0mils)
Curl in Ream	Flat within 5mm (0.02in.)
Cut Edge Conditions	Cut with sharp blades with no visible fray.
Fusing Compatibility	Must not scorch, melt, offset, or release hazardous emissions when heated to 180°C (356°F) for 0.1 second.
Grain	Long Grain
Moisture Content	4% ~ 6% by weight
Smoothness	100 ~ 250 Sheffield

## Paper Output Capacity

Output Tray	Capacity
Face-down	250 sheets of 75g/m <sup>2</sup> bond paper

## Paper Input Capacity

Input Tray	Capacity
Cassette	250 sheets of 75g/m <sup>2</sup> bond paper
MP tray	100 sheets of 75g/m <sup>2</sup> bond paper
Optional tray	500 sheets of 75g/m <sup>2</sup> bond paper

## Printer and Paper Storage Environment

Paper storage environmental conditions directly affect the feed operation.

Ideally, the printer and paper storage environment should be at or near room temperature, and not too dry or humid. Remember that paper is hygroscopic; it absorbs and loses moisture rapidly.

Heat works with humidity to damage paper. Heat causes the moisture in paper to evaporate, while cold causes it to condense on the sheets. Heating systems and air conditioners remove most of the humidity from a room. As paper is opened and used, it loses moisture, causing streaks and smudging. Humid weather or water coolers can cause the humidity to increase in a room. As paper is opened and used it absorbs any excess moisture, causing light print and dropouts. Also, as paper loses and gains moisture it can become distorted. This can cause paper jams.

Care should be taken not to purchase more paper than can be used in a short time (about 3 months). Paper stored for long periods may experience heat and moisture extremes, which can cause damage. Planning is important to prevent damage to large supplies of paper.

Unopened paper in sealed reams can remain stable for several months before use. Opened packages of paper have more potential for environment damage, especially if they are not wrapped with a moisture-proof barrier.

The paper storage environment should be properly maintained to ensure optimum printer performance. The required condition is 20° to 24°C (68° to 75°F), with a relative humidity of 45% to 55%. The following guidelines should be considered when evaluating the paper's storage environment:

- Paper should be stored at or near room temperature.
- The air should not be too dry or too humid.
- The best way to store an opened ream of paper is to rewrap it tightly in its moisture-proof wrapping. If the printer environment is subject to extremes, unwrap only the amount of paper to be used during the day's operation to prevent unwanted moisture changes.

## Envelopes

Envelope construction is critical. Envelope fold lines can vary considerably, not only between manufacturers, but also within a box from the same manufacturer. Successful printing on envelopes depends upon the quality of the envelopes. When selecting envelopes, consider the following factors:

- **Weight:** The weight of the envelope paper should not exceed 90g/m<sup>2</sup> (24lb) or jamming may occur.
- **Construction:** Prior to printing, envelopes should lie flat with less than 6mm (0.25in.) curl, and should not contain air.
- **Condition:** Envelopes should not be wrinkled, nicked, or otherwise damaged.
- **Temperature:** You should use envelopes that are compatible with the heat and pressure of the printer.
- **Size:** You should only use envelopes within the following size ranges.

	Minimum	Maximum
Multi-purpose Tray	3.5 x 5.5in. (90 x 140mm)	8.5 x 14in. (216 x 356mm)

### NOTES:

- Use only the Multi-purpose Tray to print envelopes.
- You may experience some paper jams when using any media with a length less than 140mm(5.5in.). This may be caused by paper that has been affected by environmental conditions. For optimum performance, make sure you are storing and handling the paper correctly. Please refer to "Printer and Paper Storage Environment" on page 10.3.

## Envelopes with Double Side Seams

Double side-seam construction has vertical seams at both ends of the envelope rather than diagonal seams. This style may be more likely to wrinkle. Be sure the seam extends all the way to the corner of the envelope as illustrated below.

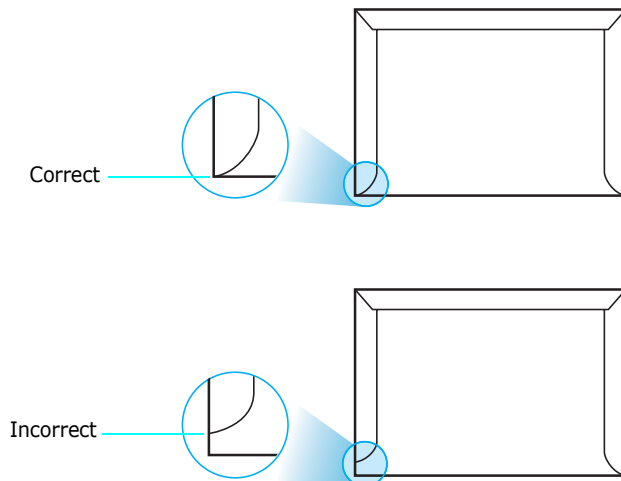

## Envelopes with Adhesive Strips or Flaps

Envelopes with a peel-off adhesive strip or with more than one flap that folds over to seal must use adhesives compatible with the heat and pressure in the printer. The extra flaps and strips might cause wrinkling, creasing, or even jams and may even damage the fuser.

## Envelope Margins

The following gives typical address margins for a commercial #10 or DL envelope.

Type of Address	Minimum	Maximum
Return address	0.6in. (15mm)	2in. (51mm)
Delivery address	2in. (51mm)	3.5in. (90mm)

### NOTES:

- For best print quality, position margins no closer than 15mm (0.6in.) from the edges of the envelope.
- Avoid printing over the area where the envelope's seams meet.

## Envelope Storage

Proper storage of envelopes helps contribute to print quality. Envelopes should be stored flat. If air is trapped in an envelope, creating an air bubble, then the envelope may wrinkle during printing. See "Printing on Envelopes" on page 4.4.

## Labels



### CAUTION:

- To avoid damaging the printer, use only labels recommended for laser printers.
- To prevent serious jams, always use the Multi-purpose Tray to print labels
- Never print on the same sheet of labels more than once and never print on a partial sheet of labels.

When selecting labels, consider the quality of each component:

- **Adhesives:** The adhesive material should be stable at 180°C (356°F), the printer's fusing temperature.
- **Arrangement:** Only use labels with no exposed backing between them. Labels can peel off sheets with spaces between the labels, causing serious jams.
- **Curl:** Prior to printing, labels must lie flat with no more than 5in. (13mm) of curl in any direction.
- **Condition:** Do not use labels with wrinkles, bubbles, or other indications of separation.

See "Printing on Labels" on page 4.5.

# INDEX

## C

- card stock, print 4.6
- cleaning
  - inside 6.8
  - outside 6.8
- components 1.3
- configuration page, print 6.1
- connecting, USB 2.7
- control panel 3.1
  - buttons 3.2
  - display 3.1
  - menus 3.3
- custom-sized materials, print 4.6

## D

- DIMM
  - installing 9.2

## E

- envelopes, print 4.4
- error messages 7.14
- Ethernet cable, connect 2.8

## F

- features
  - printer 1.1

## I

- installing
  - Memory 9.2

## L

- labels, print 4.5
- Linux
  - common problems 7.18
  - driver, install 2.9
- loading, paper
  - in the Multi-purpose Tray 4.2

- in the optional tray 4.2
- in the standard tray 4.2
- using the manual feed 4.3

## M

- Macintosh
  - common problems 7.17
  - driver, install 2.9
- manual feed mode, use 4.3
- memory DIMM
  - installing 9.2
- Multi-purpose Tray, use 4.2

## N

- network printing
  - cable, connect 2.8
  - network-connected printer, set 8.1
  - parameters, configure 8.1

## O

- option, install
  - memory DIMM 9.2

## P

- paper
  - choose 4.1
  - guideline 4.1
  - loading 4.2
  - sizes and capacities 4.1
  - specifications 10.1
- paper jams, clear 7.4
- paper size, change in the tray 2.5
- paper transfer belt, replace 6.5
- paper, load
  - in the Multi-purpose Tray 4.2
  - in the optional tray 4.2
  - in the standard tray 2.4
  - using the manual feed 4.3
- preprinted paper, print 4.5
- print quality problems, solve 7.12

- printer driver, install 2.9
- printing
  - configuration page 6.1
- problem, solve
  - checklist 7.1
  - error messages 7.14
  - general 7.2
  - Linux 7.18
  - Macintosh 7.17
  - paper jams 7.4
  - print quality 7.12
  - Windows 7.16

## Q

- quality problems, solve 7.12

## R

- replacing
  - paper transfer belt 6.5
  - toner cartridge 6.4

## S

- specification
  - paper 10.1
  - printer 10.1

## T

- toner cartridge
  - maintaining 6.2
  - redistributing 6.2
  - replacing 6.4

## U

- USB, connect 2.7



Samsung Printer

---

# Software section

# SOFTWARE SECTION

# CONTENTS

## *Chapter 1:* **INSTALLING PRINTER SOFTWARE IN WINDOWS**

Installing Printer Software .....	4
Installing Software for Local Printing .....	4
Installing Software for Network Printing .....	7
Changing the Software Language .....	10
Reinstalling Printer Software .....	10
Removing Printer Software .....	11

## *Chapter 2:* **BASIC PRINTING**

Printing a Document .....	12
Printer Settings .....	13
Layout Tab .....	13
Paper Tab .....	14
Graphics Tab .....	15
Extras Tab .....	16
About Tab .....	17
Printer Tab .....	17
Using a Favorite Setting .....	17
Using Help .....	17

## *Chapter 3:* **ADVANCED PRINTING**

Printing Multiple Pages on One Sheet of Paper (N-Up Printing) .....	18
Printing Posters .....	19
Printing Booklets .....	19
Printing on Both Sides of Paper .....	20
Printing a Reduced or Enlarged Document .....	20
Fitting Your Document to a Selected Paper Size .....	20
Using Watermarks .....	21



Using an Existing Watermark .....	21
Creating a Watermark .....	21
Editing a Watermark .....	21
Deleting a Watermark .....	21
Using Overlays .....	22
What is an Overlay? .....	22
Creating a New Page Overlay .....	22
Using a Page Overlay .....	22
Deleting a Page Overlay .....	22

## **Chapter 4: USING WINDOWS POSTSCRIPT DRIVER**

Printer Settings .....	23
<b>Advanced</b> .....	23
Using Help .....	23

## **Chapter 5: SHARING THE PRINTER LOCALLY**

Setting Up a Host Computer .....	24
Setting Up a Client Computer .....	24

## **Chapter 6: USING SMART PANEL**

Understanding Smart Panel .....	25
Opening the Troubleshooting Guide .....	25
Using Printer Settings Utility .....	26
Using Onscreen Help .....	26
Changing the Smart Panel Program Settings .....	26

## **Chapter 7: USING YOUR PRINTER IN LINUX**

System Requirements .....	27
Installing the Printer Driver .....	28
Changing the Printer Connection Method .....	29
Uninstalling the Printer Driver .....	30
Using the Configuration Tool .....	30
Changing LLPR Properties .....	31

*Chapter 8:* **USING YOUR PRINTER WITH A MACINTOSH**

Installing Software for Macintosh ..... 32

Setting Up the Printer ..... 33

    For a Network-connected Macintosh ..... 33

    For a USB-connected Macintosh ..... 33

Printing ..... 34

    Printing a Document ..... 34

    Changing Printer Settings ..... 34

    Printing Multiple Pages on One Sheet of Paper ..... 35

# 1 Installing Printer Software in Windows

This chapter includes:

- **Installing Printer Software**
- **Changing the Software Language**
- **Reinstalling Printer Software**
- **Removing Printer Software**

## Installing Printer Software

You can install the printer software for local printing or network printing. To install the printer software on the computer, perform the appropriate installation procedure depending on the printer in use.

A printer driver is software that lets your computer communicate with your printer. The procedure to install drivers may differ depending on the operating system you are using.

All applications should be closed on your PC before beginning installation.

## Installing Software for Local Printing

A local printer is a printer directly attached to your computer using the printer cable supplied with your printer, such as a USB or parallel cable. If your printer is attached to a network, skip this step and go to “Installing Software for Network Printing” on page 7.

You can install the printer software using the typical or custom method.

**NOTE:** If the “New Hardware Wizard” window appears during the installation procedure, click  in the upper right corner of the box to close the window, or click **Cancel**.

## Typical Installation

This is recommended for most users. All components necessary for printer operations will be installed.

- 1 Make sure that the printer is connected to your computer and powered on.
- 2 Insert the supplied Printer software CD into your CD-ROM drive.

The Printer software CD should automatically run, and an installation window appears.

If the installation window does not appear, click **Start** and then **Run**. Type **X:\Setup.exe**, replacing “X” with the letter which represents your drive and click **OK**.

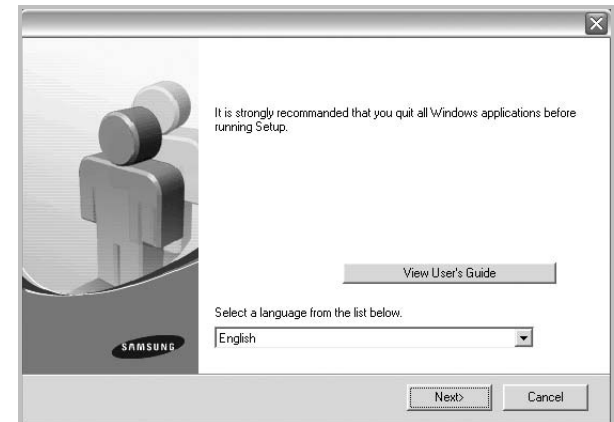

- 3 Click **Next**.
  - If necessary, select a language from the drop-down list.
  - **View User's Guide:** Allows you to view the User's Guide. If your computer doesn't have Adobe Acrobat, click on this option and it will automatically install Adobe Acrobat Reader for you.
- 4 Select **Typical installation for a local printer**. Click **Next**.

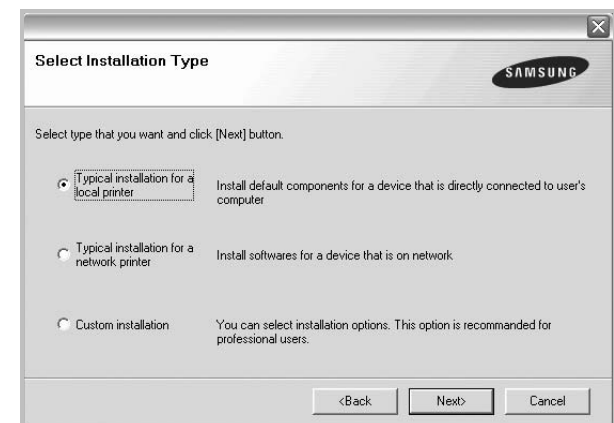

**NOTE:** If your printer is not already connected to the computer, the following window will appear.

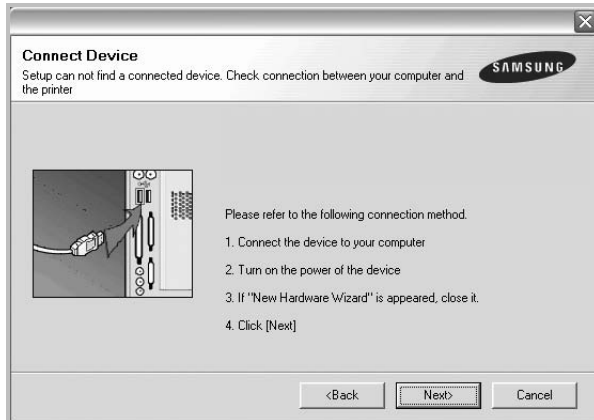

- After connecting the printer, click **Next**.
- If you don't want to connect the printer at this time, click **Next**, and **No** on the following screen. Then the installation will start and a test page will not be printed at the end of the installation.
- *The installation window that appears in this User's Guide may differ depending on the printer and interface in use.*

- 5** After the installation is finished, a window asking you to print a test page appears. If you choose to print a test page, select the checkbox and click **Next**.  
Otherwise, just click **Next** and skip to step 7.
- 6** If the test page prints out correctly, click **Yes**.  
If not, click **No** to reprint it.

- 7** To register yourself as a user of Samsung Printers in order to receive information from Samsung, select the checkbox and click **Finish**. You are now sent to the Samsung web site.

Otherwise, just click **Finish**.

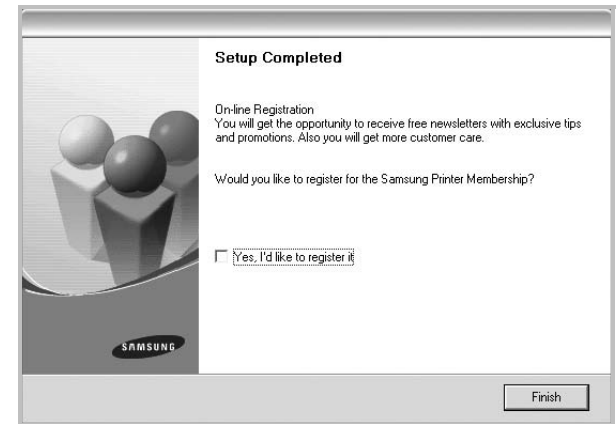

**NOTE:** After setup is complete, if your printer driver doesn't work properly, reinstall the printer driver. See "Reinstalling Printer Software" on page 10.

## Custom Installation

You can choose individual components to install.

- 1** Make sure that the printer is connected to your computer and powered on.
- 2** Insert the supplied Printer software CD into your CD-ROM drive.  
The Printer software CD should automatically run, and an installation window appears.  
If the installation window does not appear, click **Start** and then **Run**. Type **X:\Setup.exe**, replacing "X" with the letter which represents your drive and click **OK**.

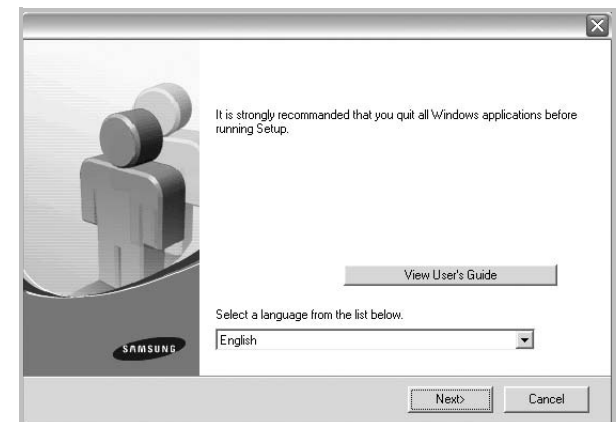

**3** Click **Next**.

- If necessary, select a language from the drop-down list.
- **View User's Guide:** Allows you to view the User's Guide. If your computer doesn't have Adobe Acrobat, click on this option and it will automatically install Adobe Acrobat Reader for you.

**4** Select **Custom installation**. Click **Next**.

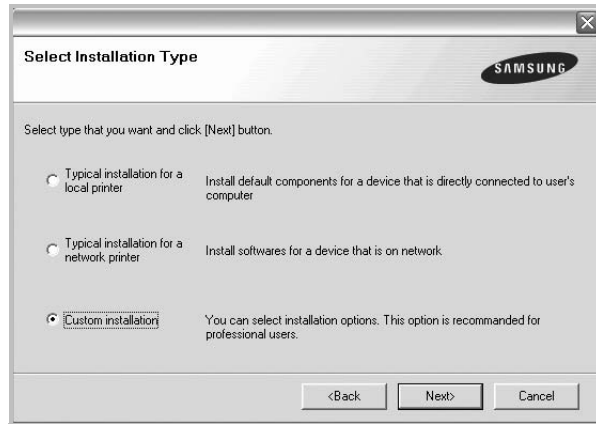

**5** Select your printer and click **Next**.

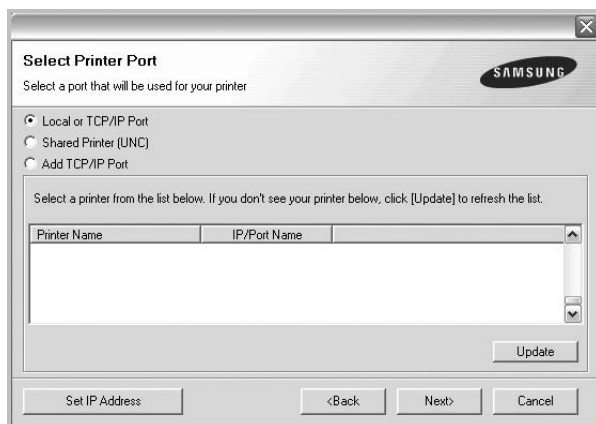

**NOTE:** If your printer is not already connected to the computer, the following window will appear.

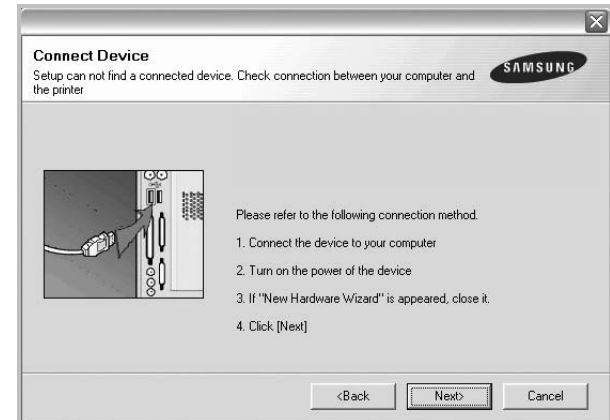

- After connecting the printer, click **Next**.
- If you don't want to connect the printer at this time, click **Next**, and **No** on the following screen. Then the installation will start and a test page will not be printed at the end of the installation.
- *The installation window that appears in this User's Guide may differ depending on the printer and interface in use.*

**6** Select the components to be installed and click **Next**.

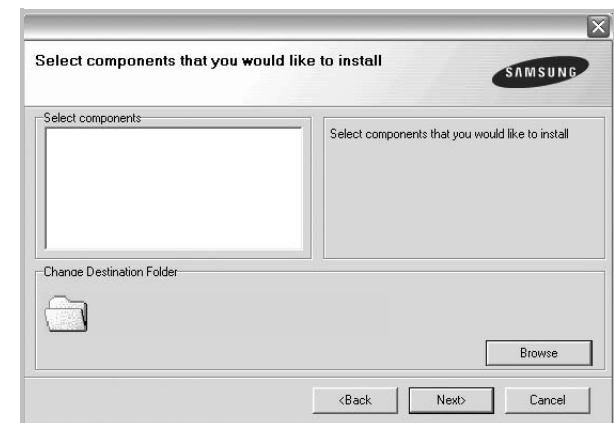

You can change the desired installation folder by clicking [Browse].

- 7** After the installation is finished, a window asking you to print a test page appears. If you choose to print a test page, select the checkbox and click **Next**. Otherwise, just click **Next** and skip to step 9.
- 8** If the test page prints out correctly, click **Yes**. If not, click **No** to reprint it.

- 9 To register yourself as a user of Samsung Printers in order to receive information from Samsung, select the checkbox and click **Finish**. You are now sent to the Samsung web site.

Otherwise, just click **Finish**.



## Installing Software for Network Printing

When you connect your printer to a network, you must first configure the TCP/IP settings for the printer. After you have assigned and verified the TCP/IP settings, you are ready to install the software on each computer on the network.

You can install the printer software using the typical or custom method.

### Typical Installation

This is recommended for most users. All components necessary for printer operations will be installed.

- 1 Make sure that the printer is connected to your network and powered on. For details about connecting to the network, see the supplied printer's User's Guide.
- 2 Insert the supplied Printer software CD into your CD-ROM drive.  
The Printer software CD should automatically run, and an installation window appears.

If the installation window does not appear, click **Start** and then **Run**. Type **X:\Setup.exe**, replacing "X" with the letter which represents your drive and click **OK**.

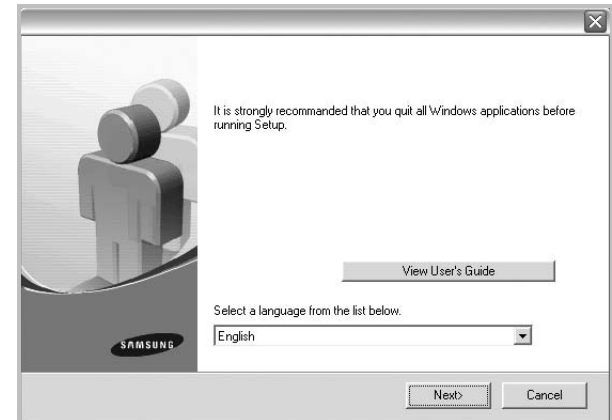

- 3 Click **Next**.
  - If necessary, select a language from the drop-down list.
  - **View User's Guide**: Allows you to view the User's Guide. If your computer doesn't have Adobe Acrobat, click on this option and it will automatically install Adobe Acrobat Reader for you.
- 4 Select **Typical installation for a network printer**. Click **Next**.

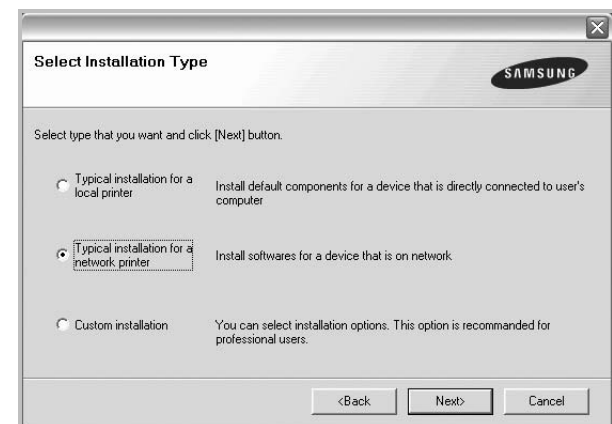

- 5 The list of printers available on the network appears. Select the printer you want to install from the list and then click **Next**.

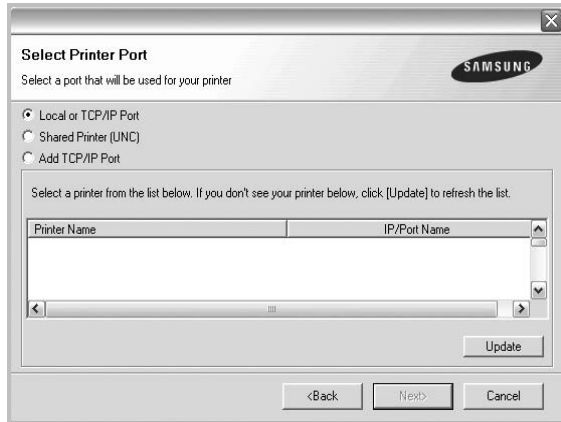

- If you do not see your printer on the list, click **Update** to refresh the list, or select **Add TCP/IP Port** to add your printer to the network. To add the printer to the network, enter the port name and the IP address for the printer.
- To find a shared network printer (UNC Path), select **Shared Printer [UNC]** and enter the shared name manually or find a shared printer by clicking the **Browse** button.

- 6 After the installation is finished, a window appears asking you to print a test page and to register yourself as a user of Samsung Printers in order to receive information from Samsung. If you so desire, select the corresponding checkbox(es) and click **Finish**.

Otherwise, just click **Finish**.

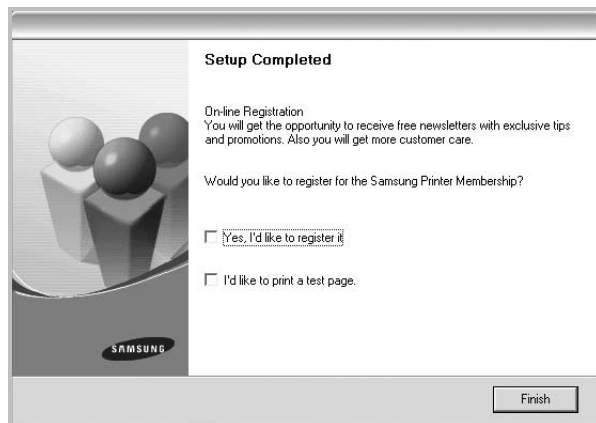

**NOTE:** After setup is complete, if your printer driver doesn't work properly, reinstall the printer driver. See "Reinstalling Printer Software" on page 10.

## Custom Installation

You can choose individual components to install and set a specific IP address.

- 1 Make sure that the printer is connected to your network and powered on. For details about connecting to the network, see the supplied printer's User's Guide.
- 2 Insert the supplied Printer software CD into your CD-ROM drive.

The Printer software CD should automatically run, and an installation window appears.

If the installation window does not appear, click **Start** and then **Run**. Type **X:\Setup.exe**, replacing "X" with the letter which represents your drive and click **OK**.

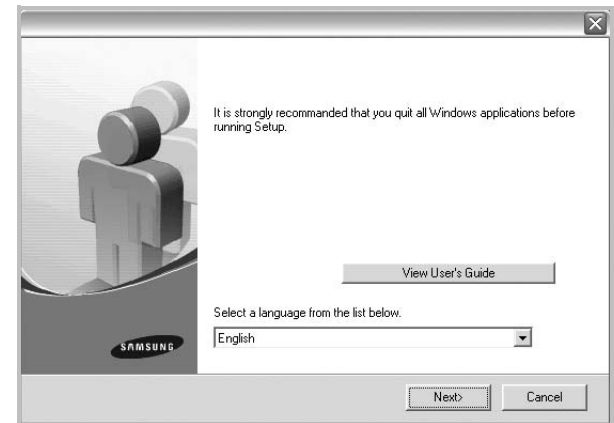

- 3 Click **Next**.
  - If necessary, select a language from the drop-down list.
  - **View User's Guide:** Allows you to view the User's Guide. If your computer doesn't have Adobe Acrobat, click on this option and it will automatically install Adobe Acrobat Reader for you.
- 4 Select **Custom installation**. Click **Next**.

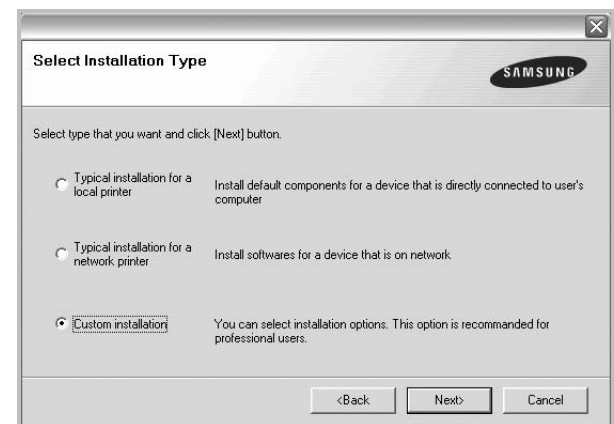

- 5 The list of printers available on the network appears. Select the printer you want to install from the list and then click **Next**.

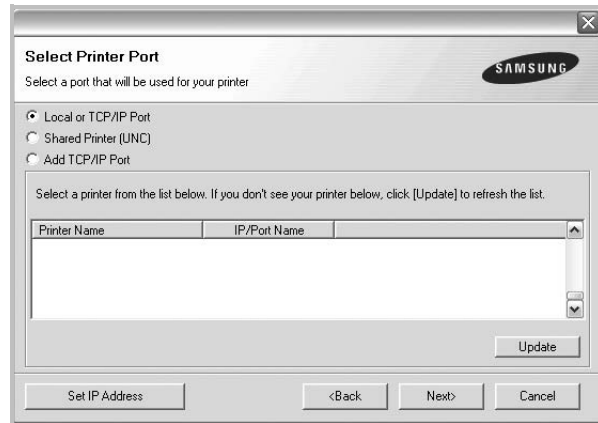

- If you do not see your printer on the list, click **Update** to refresh the list, or select **Add TCP/IP Port** to add your printer to the network. To add the printer to the network, enter the port name and the IP address for the printer.
- To find a shared network printer (UNC Path), select **Shared Printer [UNC]** and enter the shared name manually or find a shared printer by clicking the **Browse** button.

**TIP:** If you want to set a specific IP address on a specific network printer, click the **Set IP Address** button. The Set IP Address window appears. Do as follows:

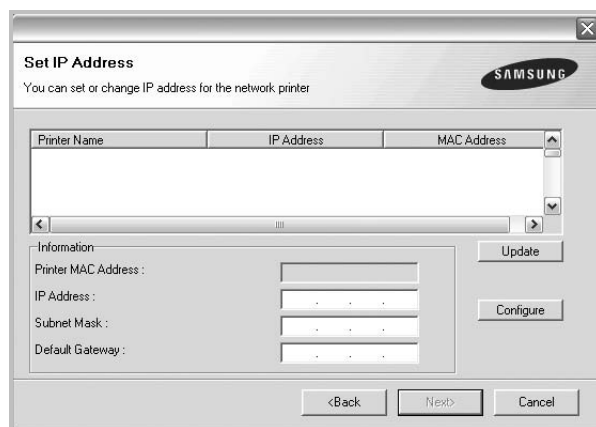

- a. Select a printer to be set with a specific IP address from the list.
- b. Configure an IP address, subnet mask, and gateway for the printer manually and click **Configure** to set the specific IP address for the network printer.
- c. Click **Next**.

- 6 Select the components to be installed. After selecting the components, the following window appears. You can also change the printer name, set the printer to be shared on the network, set the printer as the default printer, and change the port name of each printer. Click **Next**.

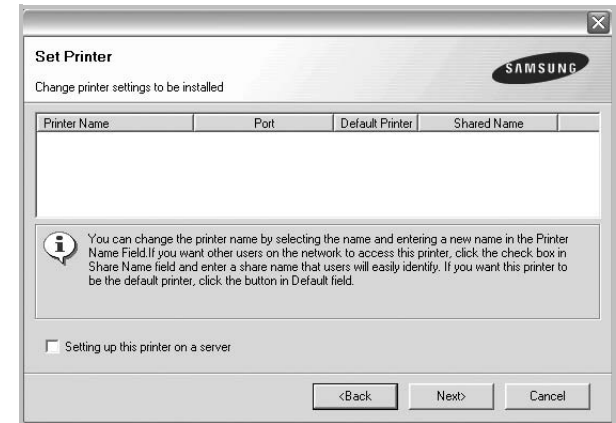

To install this software on a server, select the **Setting up this printer on a server** checkbox.

- 7 After the installation is finished, a window appears asking you to print a test page and to register yourself as a user of Samsung Printers in order to receive information from Samsung. If you so desire, select the corresponding checkbox(es) and click **Finish**.

Otherwise, just click **Finish**.

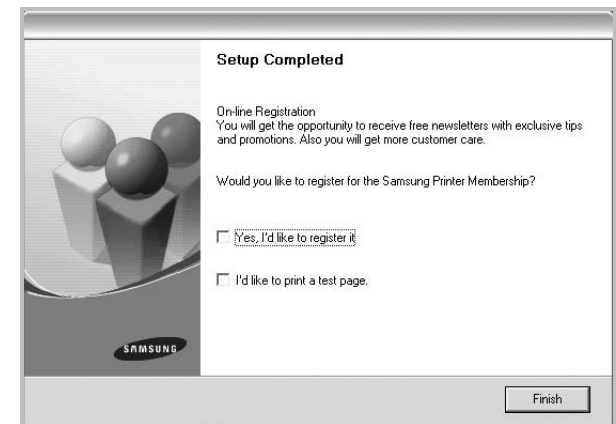

**NOTE:** After setup is complete, if your printer driver doesn't work properly, reinstall the printer driver. See "Reinstalling Printer Software" on page 10.



## Changing the Software Language

After installation of the software, you can change the display language.

- 1 Click the Windows **Start** menu.
- 2 Select **Programs** or **All Programs** and then **your printer driver name**.
- 3 Select **Language Selection**.
- 4 Select the desired language from the language selection window, and click **OK**.

## Reinstalling Printer Software

You can reinstall the software if installation fails.

- 1 Start Windows.
- 2 From the **Start** menu select **Programs** or **All Programs** → **your printer driver name** → **Maintenance**.
- 3 Select **Repair** and click **Next**.
- 4 The list of printers available on the network appears. Select the printer you want to install from the list and then click **Next**.

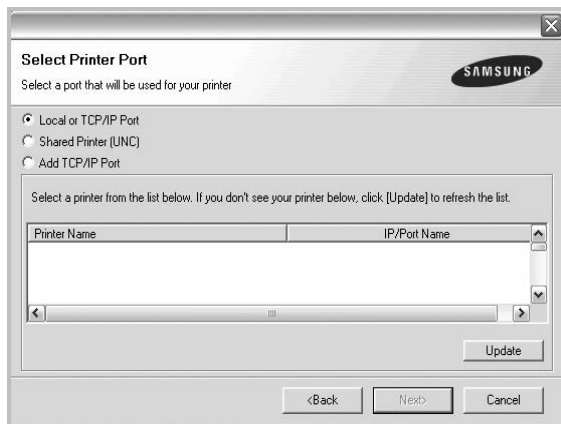

- If you do not see your printer on the list, click **Update** to refresh the list, or select **Add TCP/IP Port** to add your printer to the network. To add the printer to the network, enter the port name and the IP address for the printer.
- To find a shared network printer (UNC Path), select **Shared Printer [UNC]** and enter the shared name manually or find a shared printer by clicking the **Browse** button.

You will see a component list so that you can reinstall any item individually.

**NOTE:** If your printer is not already connected to the computer, the following window will appear.

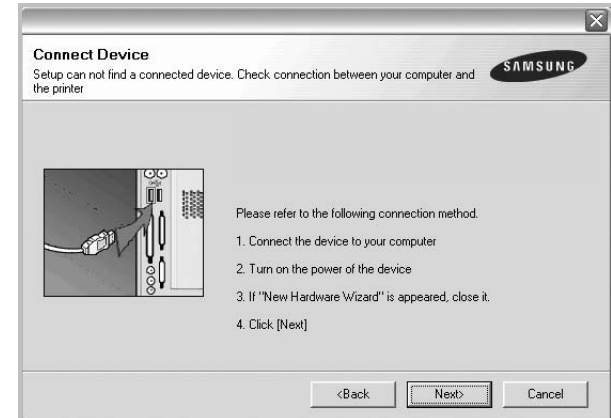

- After connecting the printer, click **Next**.
- If you don't want to connect the printer at this time, click **Next**, and **No** on the following screen. Then the installation will start and a test page will not be printed at the end of the installation.
- *The reinstallation window that appears in this User's Guide may differ depending on the printer and interface in use.*

- 5 Select the components you want to reinstall and click **Next**.

If you installed the printer software for local printing and you select **your printer driver name**, the window asking you to print a test page appears. Do as follows:

- a. To print a test page, select the check box and click **Next**.
  - b. If the test page prints out correctly, click **Yes**.  
If it doesn't, click **No** to reprint it.
- 6 When the reinstallation is done, click **Finish**.

---

## Removing Printer Software

- 1 Start Windows.
- 2 From the **Start** menu select **Programs** or **All Programs** → **your printer driver name** → **Maintenance**.
- 3 Select **Remove** and click **Next**.  
You will see a component list so that you can remove any item individually.
- 4 Select the components you want to remove and then click **Next**.
- 5 When your computer asks you to confirm your selection, click **Yes**.  
The selected driver and all of its components are removed from your computer.
- 6 After the software is removed, click **Finish**.

## 2 Basic Printing

This chapter explains the printing options and common printing tasks in Windows.

This chapter includes:

- **Printing a Document**
- **Printer Settings**
  - **Layout Tab**
  - **Paper Tab**
  - **Graphics Tab**
  - **Extras Tab**
  - **About Tab**
  - **Printer Tab**
  - **Using a Favorite Setting**
  - **Using Help**

---

### Printing a Document

---

#### NOTE:

- Your printer driver **Properties** window that appears in this User's Guide may differ depending on the printer in use. However the composition of the printer properties window is similar.
- *Check the Operating System(s) that are compatible with your printer. Please refer to the OS Compatibility section of Printer Specifications in your Printer User's Guide.*
- If you need to know the exact name of your printer, you can check the supplied Printer software CD.

The following procedure describes the general steps required for printing from various Windows applications. The exact steps for printing a document may vary depending on the application program you are using. Refer to the User's Guide of your software application for the exact printing procedure.

- 1 Open the document you want to print.
- 2 Select **Print** from the **File** menu. The Print window is displayed. It may look slightly different depending on your application.

The basic print settings are selected within the Print window. These settings include the number of copies and print range.

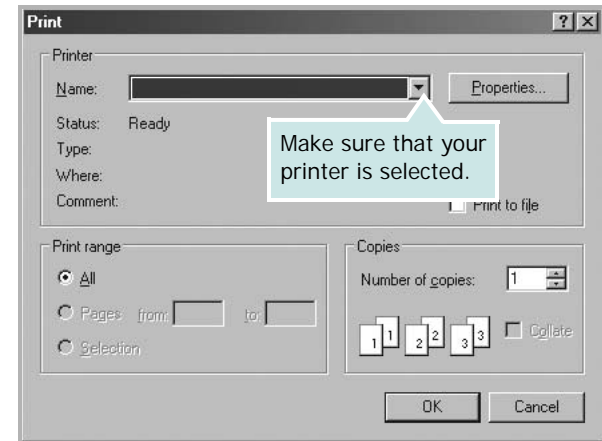

- 3 Select **your printer driver** from the **Name** drop-down list.
- 4 To take advantage of the printer features provided by your printer driver, click **Properties** or **Preferences** in the application's Print window. For details, see "Printer Settings" on page 13.  
If you see **Setup**, **Printer**, or **Options** in your Print window, click it instead. Then click **Properties** on the next screen.
- 5 Click **OK** to close the printer properties window.
- 6 To start the print job, click **OK** or **Print** in the Print window.

## Printer Settings

You can use the printer properties window, which allows you to access all of the printer options you need when using your printer. When the printer properties are displayed, you can review and change the settings needed for your print job.

Your printer properties window may differ, depending on your operating system. This Software section shows the Properties window for Windows 98.

Your printer driver **Properties** window that appears in this User's Guide may differ depending on the printer in use.

If you access printer properties through the Printers folder, you can view additional Windows-based tabs (refer to your Windows User's Guide) and the Printer tab (see "Printer Tab" on page 17).

### NOTES:

- Most Windows applications will override settings you specify in the printer driver. Change all print settings available in the software application first, and change any remaining settings using the printer driver.
- The settings you change remain in effect only while you are using the current program. **To make your changes permanent**, make them in the Printers folder.
- The following procedure is for Windows XP. For other Windows OS, refer to the corresponding Windows User's Guide or online help.
  1. Click the Windows **Start** button.
  2. Select **Printers and Faxes**.
  3. Select **your printer driver icon**.
  4. Right-click on the printer driver icon and select **Printing Preferences**.
  5. Change the settings on each tab, click OK.

## Layout Tab

The **Layout** tab provides options to adjust how the document appears on the printed page. The **Layout Options** includes **Multiple Pages per Side** and **Poster Printing**. See "Printing a Document" on page 12 for more information on accessing printer properties.

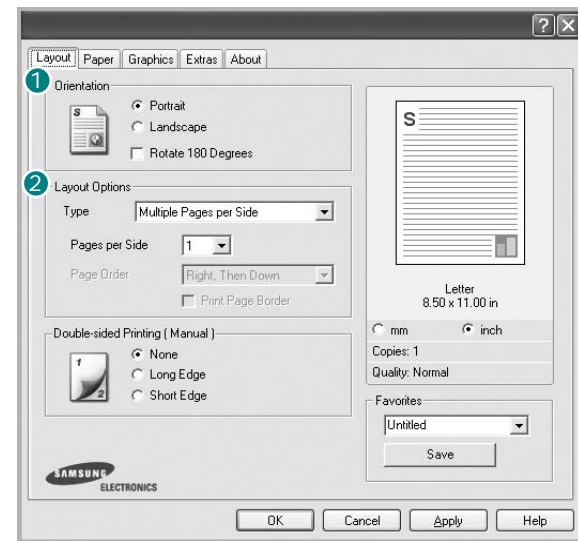

### 1 Paper Orientation

**Paper Orientation** allows you to select the direction in which information is printed on a page.

- **Portrait** prints across the width of the page, letter style.
- **Landscape** prints across the length of the page, spreadsheet style.



▲ Portrait



▲ Landscape

- **Rotate 180 Degrees** allows you to rotate the page, 180 degrees.

### 2 Layout Options

**Layout Options** allows you to select advanced printing options. You can choose **Multiple Pages per Side**, **Poster Printing** and **Booklet**.

- For details, see "Printing Multiple Pages on One Sheet of Paper (N-Up Printing)" on page 18.
- For details, see "Printing Posters" on page 19.
- For details, see "Printing Booklets" on page 19.

### 3 Double-sided Printing

**Double-sided Printing** allows you to print on both sides of paper.

- For details, see "Printing on Both Sides of Paper" on page 20.

## Paper Tab

Use the following options to set the basic paper handling specifications when you access the printer properties. See “Printing a Document” on page 12 for more information on accessing printer properties.

Click the **Paper** tab to access various paper properties.

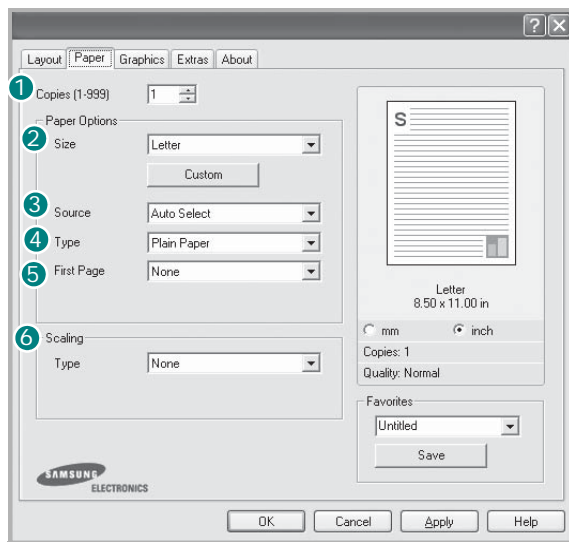

### 1 Copies

**Copies** allows you to choose the number of copies to be printed. You can select 1 to 999 copies.

### 2 Size

**Size** allows you to set the size of paper you loaded in the tray. If the required size is not listed in the **Size** box, click **Custom**. When the **Custom Paper Setting** window appears, set the paper size and click **OK**. The setting appears in the list so that you can select it.

### 3 Source

Make sure that **Source** is set to the corresponding paper tray. Use **Manual Feed** when printing on special materials like envelopes and transparencies. You have to load one sheet at a time into the Manual Tray or Multi-Purpose Tray. If the paper source is set to **Auto Select**, the printer automatically picks up print material in the following tray order: Manual Tray or Multi-Purpose Tray, Tray1, Optional Tray2

### 4 Type

Set **Type** to correspond to the paper loaded in the tray from which you want to print. This will let you get the best quality printout. If not, print quality may not be achieved as you want.  
**Cotton:** 20 lb to 24 lb (75~90 g/m<sup>2</sup>) cotton paper such as Gilbert 25 % and Gilbert 100 %.

**Plain Paper:** Normal plain paper. Select this type if your printer is monochrome and printing on the 16 lb (60 g/m<sup>2</sup>) cotton paper.

**Recycled:** 20 lb to 24 lb (75~90 g/m<sup>2</sup>) recycled paper.

**Color Paper:** 20 lb to 24 lb (75~90 g/m<sup>2</sup>) color-backgroundd paper.

### 5 First Page

This property allows you to print the first page using a different paper type from the rest of the document. You can select the paper source for the first page. For example, load thick stock for the first page into the Multi-purpose Tray, and plain paper into Tray1. Then, select **Tray1** in the **Source** option and **Multi-Purpose Tray** in the **First Page** option.

### 6 Scaling Printing

**Scaling Printing** allows you to automatically or manually scale your print job on a page. You can choose from **None**, **Reduce/Enlarge**, and **Fit to Page**.

- For details, see “Printing a Reduced or Enlarged Document” on page 20.
- For details, see “Fitting Your Document to a Selected Paper Size” on page 20.

## Graphics Tab

Use the following Graphic options to adjust the print quality for your specific printing needs. See “Printing a Document” on page 12 for more information on accessing printer properties.

Click the **Graphic** tab to display the properties shown below..

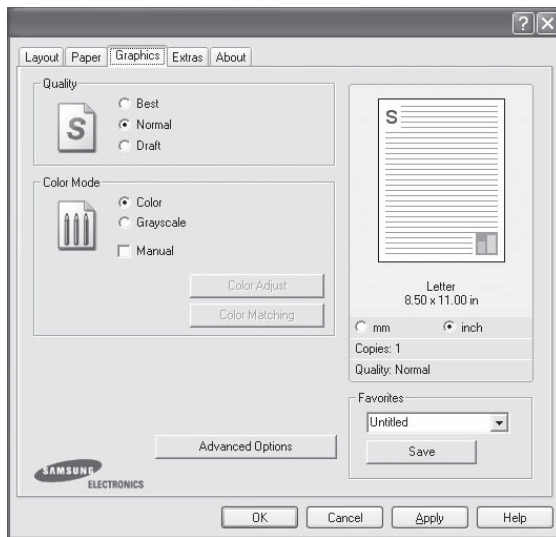

### Quality

*The Resolution options you can select may vary depending on your printer model.* The higher the setting, the sharper the clarity of printed characters and graphics. The higher setting also may increase the time it takes to print a document.

### Color Mode

You can choose color options. Setting to **Color** typically produces the best possible print quality for color documents. If you want to print a color document in grayscale, select **Grayscale**. If you want to adjust the color options manually, select **Manual** and click the **Color Adjust** or **Color Matching** button.

- **Color Adjust** : You can adjust the appearance of images by changing the settings in the **Levels** option.
- **Color Matching** : You can adjust the appearance of images by changing the settings in the **Settings** option.

### Advanced Options

You can set advanced settings by clicking the **Advanced Options** button.

- **TrueType Options**: This option determines what the driver tells the printer about how to image the text in your document. Select the appropriate setting according to the status of your document. *This option may be available only in Windows 9x/Me, depending on your particular printer model.*
  - **Download as Outline**: When this option is selected, the driver will download any TrueType fonts that are used in your document not already stored (resident) on your printer. If, after printing a document, you find that the fonts did not print correctly, choose Download as bit image and resubmit your print job. The Download as bit image setting is often useful when printing Adobe. *This feature is available only when you use the PCL printer driver.*
  - **Download as Bit Image**: When this option is selected, the driver will download the font data as bitmap images. Documents with complicated fonts, such as Korean or Chinese, or various other fonts, will print faster in this setting.
  - **Print as Graphics**: When this option is selected, the driver will download any fonts as graphics. When printing documents with high graphic content and relatively few TrueType fonts, printing performance (speed) may be enhanced in this setting.
- **Print All Text Black**: When the **Print All Text Black** option is checked, all text in your document prints solid black, regardless of the color it appears on the screen.
- **Darken Text**: When the **Darken Text** option is checked, all text in your document is allowed to print darker than on a normal document. *Some printers do not support this feature.*

## Extras Tab

You can select output options for your document. See “Printing a Document” on page 12 for more information about accessing the printer properties.

Click the **Extras** tab to access the following feature:

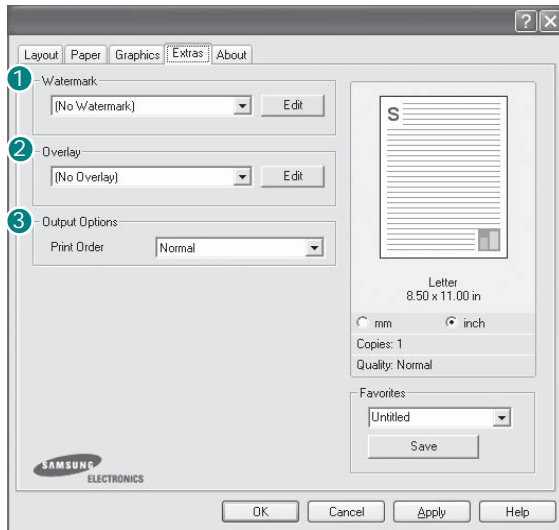

### 1 Watermark

You can create a background text image to be printed on each page of your document. For details, see “Using Watermarks” on page 21.

### 2 Overlay

Overlays are often used to take the place of preprinted forms and letterhead paper. For details, see “Using Overlays” on page 22.

---

**Notes:** The Overlay feature is not supported in NT 4.0.

---

### 3 Output Options

- **Print Order:** You can set the sequence in which the pages print. Select the print order from the drop-down list.
  - **Normal:** Your printer prints all pages from the first page to the last page.
  - **Reverse All Pages:** Your printer prints all pages from the last page to the first page.
  - **Print Odd Pages:** Your printer prints only the odd numbered pages of the document.
  - **Print Even Pages:** Your printer prints only the even numbered pages of the document.
- **Use Printer Fonts:** When Use Printer Fonts is checked, the printer uses the fonts that are stored in its memory (resident fonts) to print your document, rather than downloading the fonts used in your document. Because downloading fonts takes time, selecting this option can speed up your printing time. When using Printer fonts, the printer will try to match the fonts used in your document to those stored in its memory. If, however, you use fonts in your document that are very different from those resident in the printer, your printed output will appear very different from what it looks like on the screen.  
*This feature is available only when you use the PCL printer driver.*

## About Tab

Use the **About** tab to display the copyright notice and the version number of the driver. If you have an Internet browser, you can connect to the Internet by clicking on the web site icon. See "Printing a Document" on page 12 for more information about accessing printer properties.

## Printer Tab

If you access printer properties through the **Printers** folder, you can view the **Printer** tab. You can set the printer configuration.

The following procedure is for Windows XP. For other Windows OS, refer to the corresponding Windows User's Guide or online help.

- 1 Click the Windows **Start** menu.
- 2 Select **Printers and Faxes**.
- 3 Select **your printer driver** icon.
- 4 Right-click on the printer driver icon and select **Properties**.
- 5 Click the **Printer** tab and set the options.

## Using a Favorite Setting

The **Favorites** option, which is visible on each properties tab, allows you to save the current properties settings for future use.

To save a **Favorites** item:

- 1 Change the settings as needed on each tab.
- 2 Enter a name for the item in the **Favorites** input box.

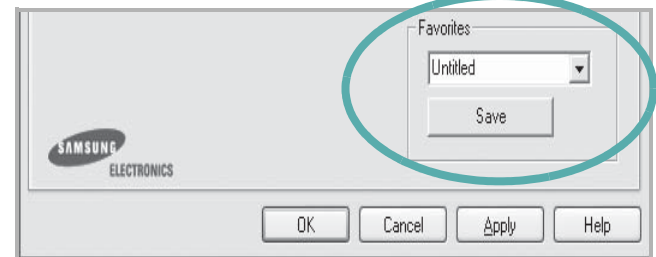

- 3 Click **Save**.

When you save **Favorites**, all current driver settings are saved.

To use a saved setting, select the item from the **Favorites** drop down list. The printer is now set to print according to the Favorites setting you selected.

To delete a Favorites item, select it from the list and click **Delete**.

You can also restore the printer driver's default settings by selecting **Printer Default** from the list.

## Using Help

Your printer has a help screen that can be activated by clicking the **Help** button in the printer properties window. These help screens give detailed information about the printer features provided by the printer driver.

You can also click  from the upper right corner of the window, and then click on any setting.



# 3 Advanced Printing

This chapter explains printing options and advanced printing tasks.

---

**NOTE:**

- Your printer driver **Properties** window that appears in this User's Guide may differ depending on the printer in use. However the composition of the printer properties window is similar.
  - If you need to know the exact name of your printer, you can check the supplied Printer software CD.
- 

This chapter includes:

- **Printing Multiple Pages on One Sheet of Paper (N-Up Printing)**
- **Printing Posters**
- **Printing Booklets**
- **Printing on Both Sides of Paper**
- **Printing a Reduced or Enlarged Document**
- **Fitting Your Document to a Selected Paper Size**
- **Using Watermarks**
- **Using Overlays**

---

## Printing Multiple Pages on One Sheet of Paper (N-Up Printing)

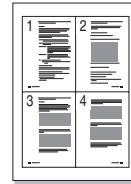

You can select the number of pages to print on a single sheet of paper. To print more than one page per sheet, the pages will be reduced in size and arranged in the order you specify. You can print up to 16 pages on one sheet.

- 1** To change the print settings from your software application, access printer properties. See “Printing a Document” on page 12.
- 2** From the **Layout** tab, choose **Multiple Pages per Side** in the **Layout Type** drop-down list.
- 3** Select the number of pages you want to print per sheet (1, 2, 4, 6, 9, or 16) in the **Pages per Side** drop-down list.
- 4** Select the page order from the **Page Order** drop-down list, if necessary.  
Check **Print Page Border** to print a border around each page on the sheet.
- 5** Click the **Paper** tab, select the paper source, size, and type.
- 6** Click **OK** and print the document.

## Printing Posters

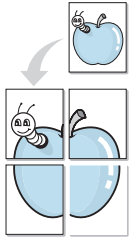

This feature allows you to print a single-page document onto 4, 9, or 16 sheets of paper, for the purpose of pasting the sheets together to form one poster-size document.

- 1 To change the print settings from your software application, access printer properties. See “Printing a Document” on page 12.
- 2 Click the **Layout** tab, select **Poster Printing** in the **Layout Type** drop-down list.
- 3 Configure the poster option:

You can select the page layout from **Poster<2x2>**, **Poster<3x3>**, or **Poster<4x4>**. If you select **Poster<2x2>**, the output will be automatically stretched to cover 4 physical pages.

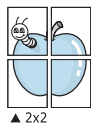

▲ 2x2

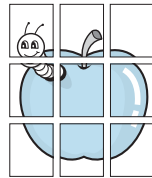

▲ 3x3

Specify an overlap in millimeters or inches to make it easier to pasting the sheets together.

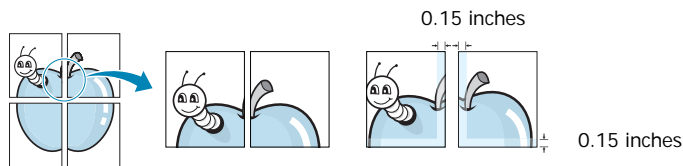

- 4 Click the **Paper** tab, select the paper source, size, and type.
- 5 Click **OK** and print the document. You can complete the poster by pasting the sheets together.

## Printing Booklets

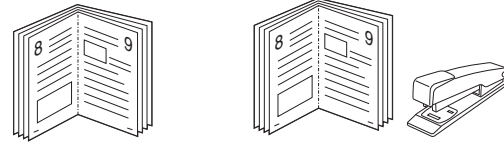

This printer feature allows you to print your document on both sides of the paper and arranges the pages so that the paper can be folded in half after printing to produce a booklet.

- 1 To change the print settings from your software application, access the printer properties. See “Printing a Document” on page 12.
- 2 From the **Layout** tab, choose **Booklet Printing** from the **Type** drop-down list.

**NOTE:** The booklet printing option is available when A4, Letter, Legal, or Folio size is selected in the **Size** option on the **Paper** tab.

- 3 Click the **Paper** tab, and select the paper source, size, and type.
- 4 Click **OK** and print the document.
- 5 After printing, fold and staple the pages.

## Printing on Both Sides of Paper

You can print on both sides of a sheet of paper. Before printing, decide how you want your document oriented.

The options are:

- **None**
- **Long Edge**, which is the conventional layout used in book binding.
- **Short Edge**, which is the type often used with calendars.

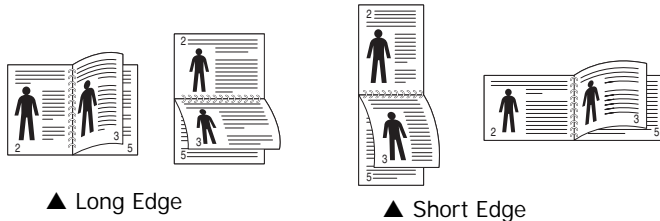

### NOTE:

- Do not print on both sides of labels, transparencies, envelopes, or thick paper. Paper jamming and damage to the printer may result.
- To use double-sided printing, you can use only the following paper sizes: A4, Letter, Legal, and Folio, with a weight of 20~24 lbs (75~90 g/m<sup>2</sup>).

- 1 To change the print settings from your software application, access printer properties. "Printing a Document" on page 12.
- 2 From the **Layout** tab, select the paper orientation.
- 3 From the **Double-sided Printing** section, select the duplex binding option you want.
- 4 Click the **Paper** tab and select the paper source, size, and type.
- 5 Click **OK** and print the document.

**NOTE:** If your printer does not have a duplex unit, you should complete the printing job manually. The printer prints every other page of the document first. After printing the first side of your job, the Printing Tip window appears. Follow the on-screen instructions to complete the printing job.

## Printing a Reduced or Enlarged Document

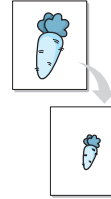

You can change the size of a page's content to appear larger or smaller on the printed page.

- 1 To change the print settings from your software application, access printer properties. See "Printing a Document" on page 12.
- 2 From the **Paper** tab, select **Reduce/Enlarge** in the **Printing Type** drop-down list.
- 3 Enter the scaling rate in the **Percentage** input box. You can also click the ▼ or ▲ button.
- 4 Select the paper source, size, and type in **Paper Options**.
- 5 Click **OK** and print the document.

## Fitting Your Document to a Selected Paper Size

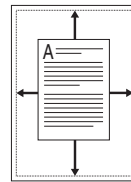

This printer feature allows you to scale your print job to any selected paper size regardless of the digital document size. This can be useful when you want to check fine details on a small document.

- 1 To change the print settings from your software application, access printer properties. See "Printing a Document" on page 12.
- 2 From the **Paper** tab, select **Fit to Page** in the **Printing Type** drop-down list.
- 3 Select the correct size from the **Target Page** drop-down list.
- 4 Select the paper source, size, and type in **Paper Options**.
- 5 Click **OK** and print the document.

---

## Using Watermarks

The Watermark option allows you to print text over an existing document. For example, you may want to have large gray letters reading "DRAFT" or "CONFIDENTIAL" printed diagonally across the first page or all pages of a document.

There are several predefined watermarks that come with the printer, and they can be modified, or you can add new ones to the list.

### Using an Existing Watermark

- 1 To change the print settings from your software application, access printer properties. See "Printing a Document" on page 12.
- 2 Click the **Extras** tab, and select the desired watermark from the **Watermark** drop-down list. You will see the selected watermark in the preview image.
- 3 Click **OK** and start printing.

---

**NOTE:** The preview image shows how the page will look when it is printed.

---

### Creating a Watermark

- 1 To change the print settings from your software application, access printer properties. See "Printing a Document" on page 12.
- 2 Click the **Extras** tab, and click the **Edit** button in the **Watermark** section. The **Edit Watermark** window appears.
- 3 Enter a text message in the **Watermark Message** box. You can enter up to 40 characters. The message displays in the preview window.  
When the **First Page Only** box is checked, the watermark prints on the first page only.
- 4 Select watermark options.  
You can select the font name, style, size, or grayscale level from the **Font Attributes** section and set the angle of the watermark from the **Message Angle** section.
- 5 Click **Add** to add a new watermark to the list.
- 6 When you have finished editing, click **OK** and start printing.

To stop printing the watermark, select **<No Watermark>** from the **Watermark** drop-down list.

## Editing a Watermark

- 1 To change the print settings from your software application, access printer properties. See "Printing a Document" on page 12.
- 2 Click the **Extras** tab and click the **Edit** button in the **Watermark** section. The **Edit Watermark** window appears.
- 3 Select the watermark you want to edit from the **Current Watermarks** list and change the watermark message and options.
- 4 Click **Update** to save the changes.
- 5 Click **OK** until you exit the Print window.

## Deleting a Watermark

- 1 To change the print settings from your software application, access printer properties. See "Printing a Document" on page 12.
- 2 From the **Extras** tab, click the **Edit** button in the Watermark section. The **Edit Watermark** window appears.
- 3 Select the watermark you want to delete from the **Current Watermarks** list and click **Delete**.
- 4 Click **OK** until you exit the Print window.

---

## Using Overlays

### What is an Overlay?



An overlay is text and/or images stored in the computer hard disk drive (HDD) as a special file format that can be printed on any document. Overlays are often used to take the place of preprinted forms and letterhead paper. Rather than using preprinted letterhead, you can create an overlay containing the exact same information that is currently on your letterhead. To print a letter with your company's letterhead, you do not need to load preprinted letterhead paper in the printer. You need only tell the printer to print the letterhead overlay on your document.

---

**Notes:** The Overlay feature is not supported in NT 4.0.

---

### Creating a New Page Overlay

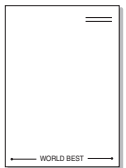

To use a page overlay, you must create a new page overlay containing your logo or image.

- 1 Create or open a document containing text or an image for use in a new page overlay. Position the items exactly as you wish them to appear when printed as an overlay.
- 2 To save the document as an overlay, access printer properties. See "Printing a Document" on page 12.
- 3 Click the **Extras** tab, and click **Edit** button in the **Overlay** section.
- 4 In the Edit Overlay window, click **Create Overlay**.
- 5 In the Create Overlay window, type a name in the **File name** box. Select the destination path, if necessary. (The default is C:\Formover).
- 6 Click **Save**. The name appears on the **Overlay List** box.
- 7 Click **OK** or **Yes** to finish creating.

The file is not printed. Instead it is stored on your computer hard disk drive.

---

**NOTE:** The overlay document size must be the same as the documents you print with the overlay. Do not create an overlay with a watermark.

---

## Using a Page Overlay

After an overlay has been created, it is ready to be printed with your document. To print an overlay with a document:

- 1 Create or open the document you want to print.
- 2 To change the print settings from your software application, access printer properties. See "Printing a Document" on page 12.
- 3 Click the **Extras** tab.
- 4 Select the desired overlay from the **Overlay** drop-down list box.
- 5 If the overlay file you want does not appear in the **Overlay** list, click **Edit** button and **Load Overlay**, and select the overlay file.

If you have stored the overlay file you want to use in an external source, you can also load the file when you access the **Load Overlay** window.

After you select the file, click **Open**. The file appears in the **Overlay List** box and is available for printing. Select the overlay from the **Overlay List** box.

- 6 If necessary, click **Confirm Page Overlay When Printing**. If this box is checked, a message window appears each time you submit a document for printing, asking you to confirm your wish to print an overlay on your document.

If this box is not checked and an overlay has been selected, the overlay automatically prints with your document.

- 7 Click **OK** or **Yes** until printing begins.

The selected overlay downloads with your print job and prints on your document.

---

**NOTE:** The resolution of the overlay document must be the same as that of the document you will print with the overlay.

---

## Deleting a Page Overlay

You can delete page overlays that you no longer use.

- 1 In the printer properties window, click the **Extras** tab.
- 2 Click the **Edit** button in the **Overlay** section.
- 3 Select the overlay you want to delete from the **Overlay List** box.
- 4 Click **Delete Overlay**.
- 5 When a confirming message window appears, click **Yes**.
- 6 Click **OK** until you exit the Print window.

# 4 Using Windows PostScript Driver

If you want to use the PostScript driver provided with your system CD-ROM to print a document.

PPDs, in combination with the PostScript driver, access printer features and allow the computer to communicate with the printer. An installation program for the PPDs is provided on the supplied software CD-ROM.

This chapter includes:

---

## Printer Settings

You can use the printer properties window, which allows you to access all of the printer options you need when using your printer. When the printer properties are displayed, you can review and change the settings needed for your print job.

Your printer properties window may differ, depending on your operating system. This Software User's Guide shows the Properties window for Windows XP.

Your printer driver **Properties** window that appears in this User's Guide may differ depending on the printer in use.

---

### NOTES:

- Most Windows applications will override settings you specify in the printer driver. Change all print settings available in the software application first, and change any remaining settings using the printer driver.
  - The settings you change remain in effect only while you are using the current program. **To make your changes permanent**, make them in the Printers folder.
  - The following procedure is for Windows XP. For other Windows OS, refer to the corresponding Windows User's Guide or online help.
    1. Click the Windows **Start** button.
    2. Select **Printers and Faxes**.
    3. Select **your printer driver icon**.
    4. Right-click on the printer driver icon and select **Printing Preferences**.
    5. Change the settings on each tab, click OK.
- 

## Advanced

You can use advanced settings by clicking the **Advanced** button.

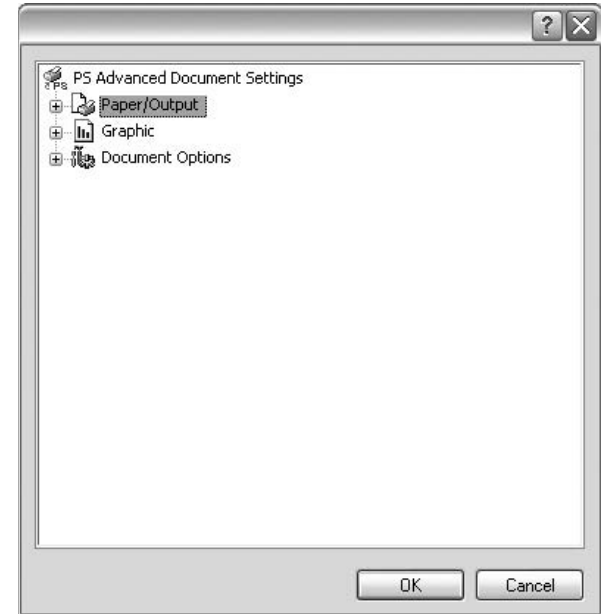

- **Paper/Output** this option allows you to select the size of the paper loaded in the tray.
- **Graphic** this option allows you to adjust the print quality for your specific printing needs.
- **Document Options** this options allow you to set the PostScript options or printer features.

## Using Help

You can click  from the upper right corner of the window, and then click on any setting.

# 5 Sharing the Printer Locally

You can connect the printer directly to a selected computer, which is called “host computer,” on the network.

The following procedure is for Windows XP. For other Windows OS, refer to the corresponding Windows User's Guide or online help.

---

## NOTES:

- Check the Operating System(s) that are compatible with your printer. Please refer to the OS Compatibility section of Printer Specifications in your Printer User's Guide.
  - If you need to know the exact name of your printer, you can check the supplied Printer software CD.
- 

---

## Setting Up a Host Computer

- 1 Start Windows.
- 2 From the **Start** menu select **Printers and Faxes**.
- 3 Double-click **your printer driver icon**.
- 4 From the **Printer** menu, select **Sharing**.
- 5 Check the **Share this printer** box.
- 6 Fill in the **Shared Name** field, and then click **OK**.

---

## Setting Up a Client Computer

- 1 Right-click the Windows **Start** button and select **Explorer**.
- 2 Open your network folder in the left column.
- 3 Click the shared name.
- 4 From the **Start** menu select **Printers and Faxes**.
- 5 Double-click **your printer driver icon**.
- 6 From the **Printer** menu, select **Properties**.
- 7 From the **Ports** tab, click **Add Port**.
- 8 Select **Local Port** and click **New Port**.
- 9 Fill in the **Enter a port name** field with the shared name.
- 10 Click **OK** and click **Close**.
- 11 Click **Apply** and click **OK**.

# 6 Using Smart Panel

Smart Panel is a program that monitors and informs you of the status of the printer, and allows you to customize the printer's settings. Smart Panel is installed automatically when you install the printer software.

## NOTES:

- To use this program, you need:
  - Windows 98 or higher (Windows NT 4.0 can be used only for network-supported printers.) To check for Operating System(s) that are compatible with your printer, refer to Printer Specifications in your Printer User's Guide.
  - Internet Explorer version 5.0 or higher for flash animation in HTML Help.
- If you need to know the exact name of your printer, you can check the supplied Printer software CD.

## Understanding Smart Panel

If an error occurs while printing, Smart Panel appears automatically, showing the error. You can also launch Smart Panel manually from the Windows task bar. Double-click the Smart Panel icon on the Windows task bar.

Double click this icon.

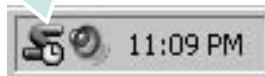

Or, from the **Start** menu, select **Programs** or **All Programs** → **your printer driver name** → **Smart Panel**.

## NOTES:

- If you have already installed more than one Samsung printer, first select the printer model you want in order to use the corresponding Smart Panel. Right-click the Smart Panel icon on the Windows task bar and select **your printer name**.
- The Smart Panel window and its contents shown in this Software section may differ depending on the printer in use.

The Smart Panel program displays the current status of the printer, various information, lets you change settings and the level of toner remaining in the toner cartridge(s).

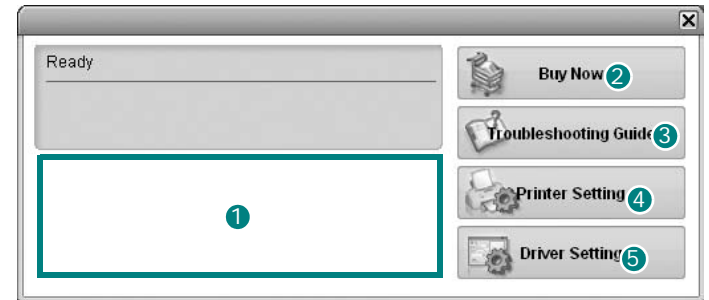

### 1 Toner Level

You can view the level of toner remaining in the toner cartridge(s). The printer and the number of the toner cartridge(s) shown above window may differ depending on the printer in use.

### 2 Buy Now

You can order replacement toner cartridge online.

### 3 Troubleshooting Guide

You can view Help to solve problems.

### 4 Printer Setting

You can configure various printer settings in the Printer Settings Utility window.

**NOTES:** If you connect your printer to a network, the **SyncThru Web Service** window appears instead of the Printer Settings Utility window.

### 5 Driver Setting

You can use the printer properties window, which allows you to access all of the printer options you need for using your printer. For details, See "Printer Settings" on page 13.

## Opening the Troubleshooting Guide

Using the troubleshooting guide, you can view solutions for error status problems.

Right-click the Smart Panel icon on the Windows task bar and select **Troubleshooting Guide**.



## Using Printer Settings Utility

Using the Printer Settings Utility, you can configure and check print settings.

- 1 Right-click the Smart Panel icon on the Windows task bar and select **Printer Setting**.
- 2 Change the settings.
- 3 To send the changes to the printer, click the **Send** button.

**NOTES:** If you connect your printer to a network, the **SyncThru Web Service** window appears instead of the Printer Settings Utility window.

## Using Onscreen Help

You can view **Printer Settings Utility** help on screen.

To get a help, right-click on a text item or icon, and then select "What's this?". A small window with an explanation will appear.

## Changing the Smart Panel Program Settings

Right-click the Smart Panel icon on the Windows task bar and select **Options**.

The following window opens.

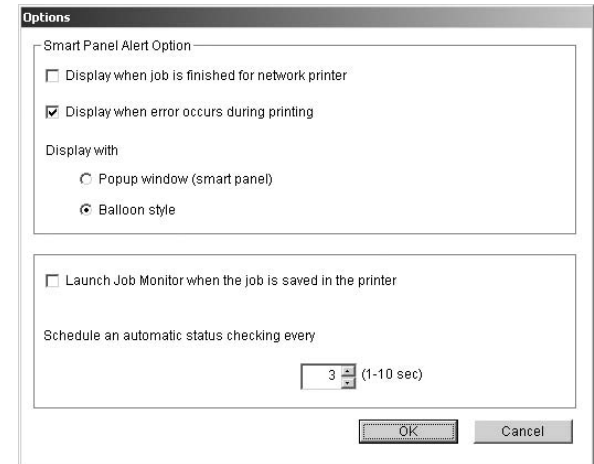

- **Display when job is finished for network printer:** The computer shows the Smart Panel popup window or balloon when your job is complete. *(Only for a network supported printer.)*
- **Display when error occurs during printing:** The computer shows the Smart Panel popup window or balloon when an error occurs during printing.
- **Display with:** You can select how the computer shows you a message. If you select **Popup window (smart panel)**, the message appears in the Smart Panel popup window.
- **Launch Job Monitor when the job is saved in the printer:** If you store print jobs on the printer's hard disk, the computer opens the Job Monitor window. *(Only for a network supported printer with a built-in hard disk.)*
- **Schedule an automatic status checking every:** The computer updates the printer status regularly. Setting the value close to 1 second causes the computer to check the printer status more frequently, thereby allowing a faster response to any printer error.

# 7 Using Your Printer in Linux

You can use your printer in a Linux environment.

This chapter includes:

- **System Requirements**
- **Installing the Printer Driver**
- **Changing the Printer Connection Method**
- **Uninstalling the Printer Driver**
- **Using the Configuration Tool**
- **Changing LLPR Properties**

---

## System Requirements

### Supported OS

- Redhat 7.1 and above
- Linux Mandrake 8.0 and above
- SuSE 7.1 and above
- Caldera OpenLinux 3.1 and above
- Turbo Linux 7.0 and above
- Slackware 8.1 and above

### Recommended Capacities

- Pentium IV 1 GHz or higher
- RAM 256 MB or higher
- HDD 1 GB or higher

### Software

- Glibc 2.1 or higher
- GTK+ 1.2 or higher
- GhostScript

---

### NOTES:

- The Linux printer's properties window that appears in this User's Guide may differ depending on the printer in use. However the composition of the properties is similar.
  - *You can check your printer name in the supplied Printer software CD.*
-

## Installing the Printer Driver

- 1 Make sure that you connect the printer to your computer. Turn both the computer and the printer on.
- 2 When the Administrator Login window appears, type in “root” in the **Login** field and enter the system password.

**NOTE:** You must log in as a super user (root) to install the printer software. If you are not a super user, ask your system administrator.

- 3 Insert the printer software CD. The CD-ROM automatically runs.

**NOTE:** If the printer software CD does not automatically run, click the  icon at the bottom of the window. When the Terminal screen appears, type in:

```
[root@local /root]# mount -t iso9660 /dev/hdc /mnt/  
cdrom (Assuming that /dev/hdc is your Printer software CD  
and you have /mnt/cdrom directory)  
[root@local /root]# cd /mnt/cdrom (the CD-ROM directory)  
[root@local cdrom]# ./setup.sh
```

- 4 Select the type of installation, either **Recommended** or **Expert**, and then click **Continue**.



**Recommended** is fully automated and does not require any interaction. **Expert** installation allows you to select the install path or printing system.

- 5 If you selected **Recommended**, go to step 6.

For **Expert**, select the desired option and then click **Begin Install**.

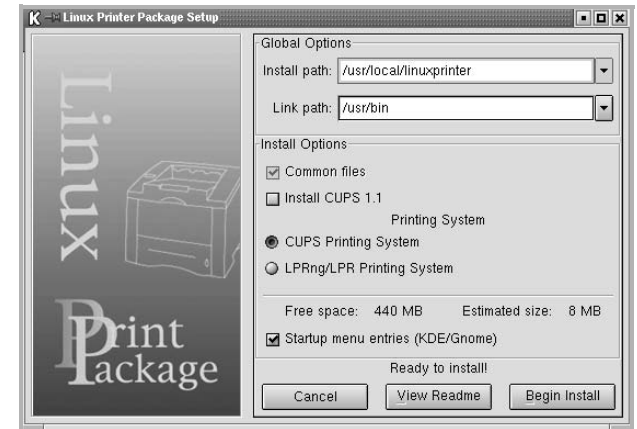

- 6 The printer driver installation begins. When the installation is completed, click **Start**.

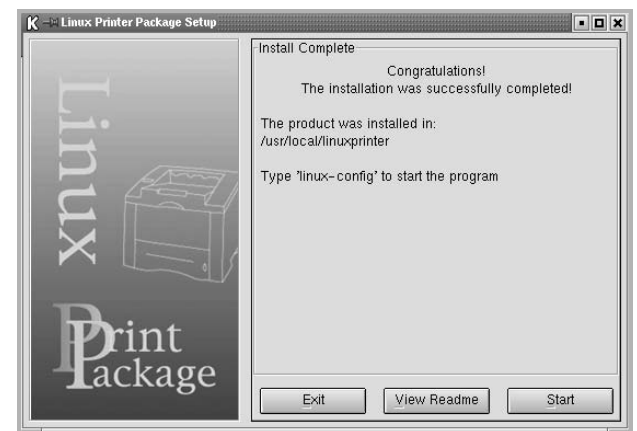

- 7 The Linux Printer Configuration window opens. Click the **Add Printer** icon on the toolbar at the top of the window.

**NOTE:** Depending on the printing system in use, the Administrator Login window may appear. Type in “root” in the **Login** field and enter the system password.

- 8 You see the printers currently installed in your system. Select the printer you want to use. The function tabs available for the selected printer appear at the top of the Add a Printer window.

**NOTE:** If the printer supports PS printing, it is recommended to select the PS driver.

- 9 Click the **Connection** tab and ensure that the printer port is set properly. If it is not, change the device setting.



- 10 You can use the **Settings** tab and the **Queue** tab to view the printer's current settings. If necessary, you can change the settings.

**NOTE:** Options may differ depending on the printer in use. The **Description** and the **Location** field in the Queue screen may not appear depending on the printing system in use.

- 11 To exit, click **OK**.
- 12 When the window indicates that the new printer is successfully configured, click **OK**.
- 13 The Linux Printer Configuration window reappears. From the **Info** tab, you can view information about your printer driver. If necessary, you can change the printer's configuration. For details about changing the printer's configuration, see "Using the Configuration Tool" on page 30.



## Changing the Printer Connection Method

If you change the printer connection method from USB to parallel or vice versa while in use, you must reconfigure your Linux printer by adding the printer to your system. Take the following steps:

- 1 Make sure that you connect the printer to your computer. Turn both the computer and the printer on.
- 2 When the Administrator Login window appears, type in "**root**" in the Login field and enter the system password.

**NOTE:** You must log in as a super user (root) to install a new printer to the printing system. If you are not a super user, ask your system administrator.

- 3 From the Startup Menu icon at the bottom of the desktop, select **Linux Printer** and then **Configuration Tool**. You can also access the Linux Printer Configuration window by typing in "**linux-config**" from the Terminal screen.
- 4 When the Linux Printer Configuration window appears, click the **Add Printer** icon on the toolbar at the top of the window.
- 5 Click the **Connection** tab at the top of the Add a Printer window.

Ensure that the printer port is set properly. If it is not, change the device setting.



- 6 Click **OK**.

## Uninstalling the Printer Driver

- 1 From the Startup Menu icon at the bottom of the desktop, select **Linux Printer** and then **Configuration Tool**.

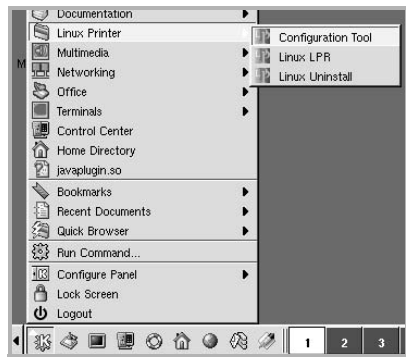

You can also access the Linux Printer Configuration window by typing in "**linux-config**" from the Terminal screen.

- 2 In the Linux Printer Configuration window, select the **Uninstall** command from the **File** menu.
- 3 The Administrator Login window appears. Type in "**root**" in the **Login** field and enter the system password. Click **Proceed**.

**NOTE:** You must log in as a super user (root) to uninstall the printer software. If you are not a super user, ask your system administrator.

- 4 A message window asking for confirmation to proceed with the uninstallation appears. Click **Yes**.
- 5 Select **Complete uninstall** and then click **Uninstall**.

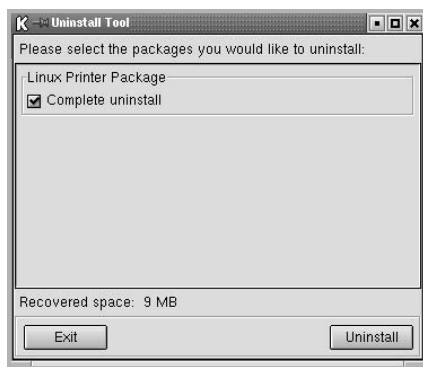

- 6 Click **OK** to begin uninstallation.
- 7 When the uninstallation is completed, click **Finished**.

## Using the Configuration Tool

The configuration tool accesses administrative tasks, including adding and removing new printers, and changing their global settings. Regular users can also run it to easily inspect job queues, examine printer properties and changing their local preferences.

To access the Configuration Tool:

- 1 From the Startup Menu icon at the bottom of the screen, select **Linux Printer** and then **Configuration Tool**. The Linux Printer Configuration window appears. You can also open this window from the Terminal screen by typing in "**linux-config**."
- 2 The Linux Printer Configuration window shows a list of installed printers in the left pane. The right pane shows a number of tabs that display information regarding the currently selected printer. Select your printer driver, if not currently selected.

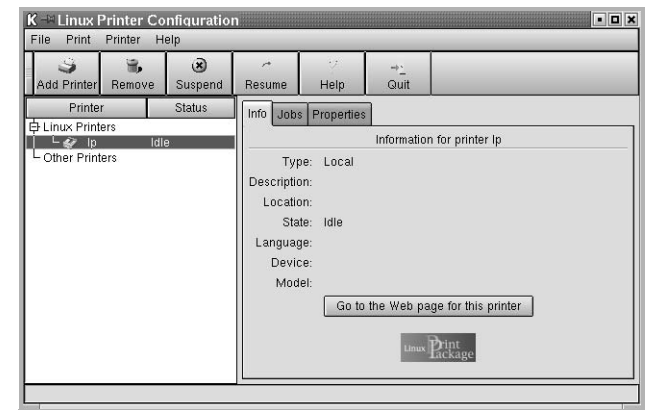

- 3 The **Info** tab shows general information about the printer. If you are an Internet user, you can click **Go to the Web page for this printer** to access the Samsung web page. Click the **Job** tab to inspect and manage the job queue for the selected printer. You can suspend, resume, or delete a specific job(s) in the queue. If you drag a specific job(s), you can drop it into the print queue of another printer.

The **Properties** tab allows you to change the default printer settings.

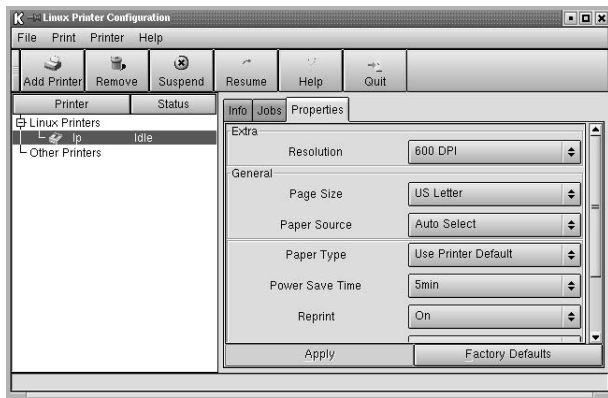

**NOTE:** Regular users are able to override the system-wide default settings defined by the administrator. When a regular user clicks **Apply**, these custom settings will be saved in the user's profile and may be used later with LLPR. If the administrator is running the configuration tool, then the settings will be saved as the new global defaults.

## Changing LLPR Properties

You can fine-tune the printer's properties by opening the LLPR Properties window.

To open the LLPR Properties window:

- 1 From the application you are using, select the **Print** command.
- 2 When the Linux LPR window opens, click **Properties**.

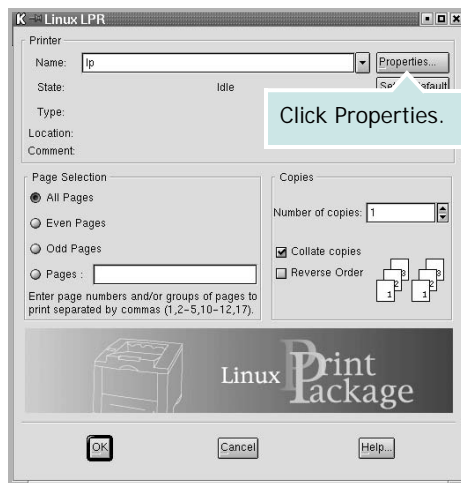

You can also open the LLPR Properties window in the following ways:

- From the Startup Menu icon at the bottom of the screen, select **Linux Printer**, and then **Linux LPR**.
  - If the Linux Printer Configuration window is currently open, select **Test Print** from the **Print** menu.
- 3 The LLPR Properties window opens.

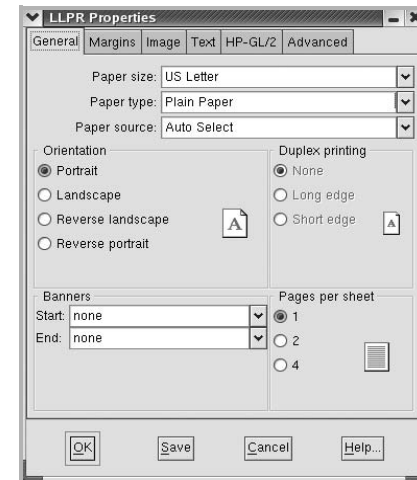

You will see the following six tabs at the top of the window:

- **General** - allows you to change the paper size, the paper type, the paper source, the orientation of the documents, enable the duplex feature, add start and end banners, and change the number of pages per sheet.
- **Margins** - allows you to specify the page margins. The graphics on the right show the current settings. These margins do not apply when printing regular PostScript data.
- **Image** - allows you to set image options that will be used when printing image files, i.e., when a non-PostScript document is passed to LLPR on the command line. Color settings will also take effect for postscript documents.
- **Text** - allows you to select the text density and turn the syntax coloring on or off.
- **HP-GL/2** - allows you to set default options to print HP-GL/2 format documents, used by some plotters.
- **Advanced** - allows you to override the default settings for the printer.

If you click the **Save** button at the bottom of the window, the options will be retained between LLPR sessions.

Use the **Help** button to view details about the options in the window.

- 4 To apply the options, click **OK** in the LLPR Properties window. You will return to the Linux LPR window. To start printing, click **OK**.

# 8 Using Your Printer with a Macintosh

Your machine supports Macintosh systems with a built-in USB interface or a 10/100 Base-TX network interface card. When you print a file from a Macintosh computer, you can use the PostScript driver by installing the PPD file.

**NOTE:** *Some printers do not support a network interface. Make sure that your printer supports a network interface by referring to Printer Specifications in your Printer User's Guide.*

This chapter includes:

- **Installing Software for Macintosh**
- **Setting Up the Printer**
- **Printing**

## Installing Software for Macintosh

The PostScript driver CD-ROM that came with your machine provides you with the PPD file to use the PS driver, Apple LaserWriter driver, for printing on a Macintosh computer.

Verify the following before you install the printer software:

Item	Requirements	
Operating system	Mac OS 8.6 ~ 9.2/10.1 or higher	
RAM	Mac OS 8.6~9.2	64 MB
	Mac OS 10.1 or higher	128 MB
Free disk space	200 MB	
Connection	USB interface, Network interface	

- 1 Connect your machine to the computer using the USB cable or the Ethernet cable.
- 2 Turn on your computer and the machine.
- 3 Insert the PostScript driver CD-ROM which came with your machine into the CD-ROM drive.
- 4 Double-click the **Samsung\_CLBP** on your Macintosh desktop.
- 5 Double-click the **MAC\_Installer** folder.
- 6 Double-click the **Samsung\_CLBP Installer OSX** icon.
- 7 Click **Continue**.
- 8 Click **Install**.
- 9 After the installation is finished, click **Quit**.

---

## Setting Up the Printer

Set up for your printer will be different depending on which cable you use to connect the printer to your computer—the network cable or the USB cable.

### For a Network-connected Macintosh

---

**NOTE:** *Some printers do not support a network interface. Before connecting your printer, make sure that your printer supports a network interface by referring to Printer Specifications in your Printer User's Guide.*

---

#### Mac OS 8.6 ~ 9.2

- 1 Follow the instructions on “Installing Software for Macintosh” on page 32 to install the PPD file on your computer.
- 2 From the **Apple** menu, select **Chooser**.
- 3 Click **LaserWriter 8** (the PostScript driver provided with your Macintosh).  
The name of your machine appears on the list.
- 4 Select **SEC000xxxxxxxx** from the printer box (where the xxxxxxxx varies depending on each of the machines) and Click **Select**.  
If Auto Setup does not work properly, click **Select PPD**, choose **your printer name**, and click **OK**.
- 5 When the setup is complete, you see your machine icon created as a desktop printer.
- 6 Close the **Chooser**.
- 7 When a message window appears telling you that you have changed your current machine, click **OK**.

#### Mac OS 10.1 or higher

- 1 Follow the instructions on “Installing Software for Macintosh” on page 32 to install the PPD file on your computer.
- 2 Open **Print Center** or **Printer Setup Utility** from the Utilities folder.
- 3 Click **Add** on the Printer List.
- 4 Select the **AppleTalk** tab.  
The name of your machine appears on the list. Select **SEC000xxxxxxxx** from the printer box, where the xxxxxxxx varies depending on your machine.
- 5 Click **Add**.
- 6 If Auto Select does not work properly, select **Samsung** in **Printer Model** and **your printer name** in **Model Name**.  
Your machine appears on the Printer List. And you can set your machine as the default printer.

### For a USB-connected Macintosh

#### Mac OS 10.1 or higher

- 1 Follow the instructions on “Installing Software for Macintosh” on page 32 to install the PPD file on your computer.
- 2 Open **Print Center** or **Printer Setup Utility** from the Utilities folder.
- 3 Click **Add** on the Printer List.
- 4 Select the **USB** tab.
- 5 Select **your printer name** and click **Add**.
- 6 If Auto Select does not work properly, select **Samsung** in **Printer Model** and **your printer name** in **Model Name**.  
Your machine appears on the Printer List. And you can set your machine as the default printer.



# Printing

## NOTES:

- The Macintosh printer's properties window that appears in this User's Guide may differ depending on the printer in use. However the composition of the printer properties window is similar.
- *You can check your printer name in the supplied Printer software CD.*

## Printing a Document

When you print with a Macintosh, you need to check the printer software setting in each application you use. Follow these steps to print from a Macintosh.

- 1 Open a Macintosh application and select the file you want to print.
- 2 Open the **File** menu and click **Page Setup (Document Setup** in some applications).
- 3 Choose your paper size, orientation, scaling, and other options and click **OK**.

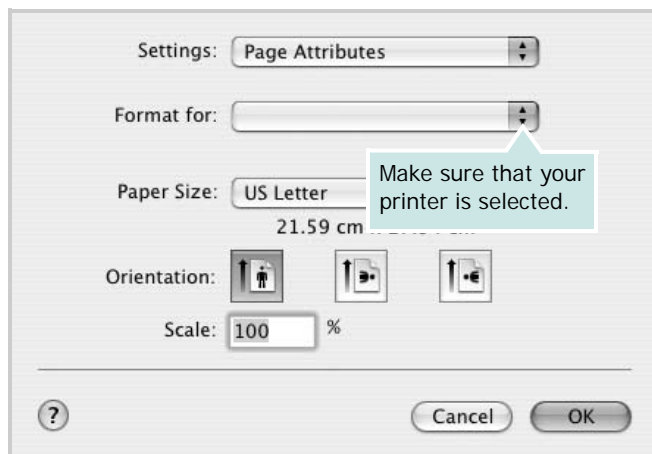

▲ Mac OS 10.3

- 4 Open the **File** menu and click **Print**.
- 5 Choose the number of copies you want and indicate which pages you want to print.
- 6 Click **Print** when you finish setting the options.

## Changing Printer Settings

You can use advanced printing features when using your printer.

From your Macintosh application, select **Print** from the **File** menu. The printer name which appears in the printer properties window may differ depending on the printer in use. Except for the name, the composition of the printer properties window is similar.

## Layout Setting

The **Layout** tab provides options to adjust how the document appears on the printed page. You can print multiple pages on one sheet of paper.

Select **Layout** from the **Presets** drop-down list to access the following features. For details, see "Printing Multiple Pages on One Sheet of Paper" on the next column.

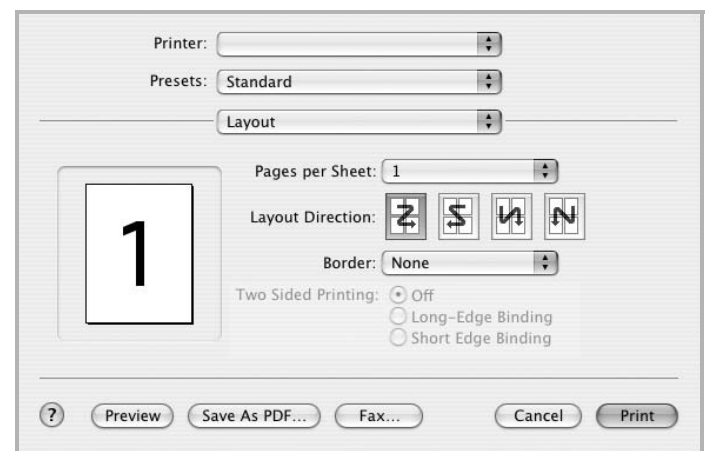

▲ Mac OS 10.3

## Printer Features Setting

The **Printer Features** tab provides options for selecting the paper type and adjusting print quality.

Select **Printer Features** from the **Presets** drop-down list to access the following features:



▲ Mac OS 10.3

## Fit to Page

This printer feature allows you to scale your print job to any selected paper size regardless of the digital document size. This can be useful when you want to check fine details on a small document.

## Paper Type

Set type to correspond to the paper loaded in the tray from which you want to print. This will let you get the best quality printout.

## Resolution(Quality)

*The Resolution options you can select may vary depending on your printer model.* You can select the printing resolution. The higher the setting, the sharper the clarity of printed characters and graphics. The higher setting also may increase the time it takes to print a document.

## Color Mode

You can set the color options. Setting to **Color** typically produces the best possible print quality for color documents. If you want to print a color document in grayscale, select **Grayscale**.

## Printing Multiple Pages on One Sheet of Paper

You can print more than one page on a single sheet of paper. This feature provides a cost-effective way to print draft pages.

- 1 From your Macintosh application, select **Print** from the **File** menu.
- 2 Select **Layout**.

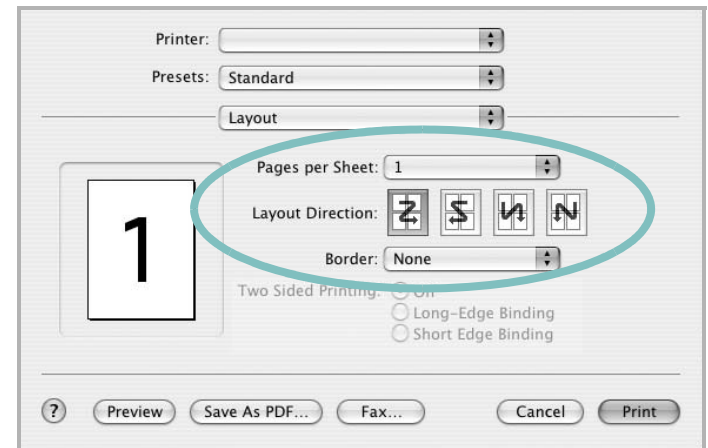

▲ Mac OS 10.3

- 3 Select the number of pages you want to print on one sheet of paper on the **Pages per Sheet** drop-down list.
- 4 Select the page order from the **Layout Direction** option. To print a border around each page on the sheet, select the option you want from the **Border** drop-down list.
- 5 Click **Print**, and the printer prints the selected number of pages on one side of each page.

# SOFTWARE SECTION

# INDEX

## A

advanced printing, use 18

## B

booklet printing 19

## D

document, print

Macintosh 34

Windows 12

double-sided printing 20

## E

Extras properties, set 16

## F

favorites settings, use 17

## G

Graphics properties, set 15

## H

help, use 17, 23

## I

install

printer driver

Linux 28

Macintosh 32

Windows 4

## L

language, change 10

Layout properties, set

Linux 31

Macintosh 34

Windows 13

Linux

configuration tool 30

driver

install 28

uninstall 30

LLP properties 31

## M

Macintosh

driver

install 32

printing 34

setting up the printer 33

## N

n-up printing

Macintosh 35

Windows 18

## O

orientation, print

Windows 13

overlay

create 22

delete 22

print 22

## P

Paper properties, set 14

paper size, set 14

paper source, set

Linux 31

Windows 14

paper type, set

Linux 31

Macintosh 35

poster, print 19

PostScript driver

installing 23

print

document 12

fit to page 20

from Macintosh 34

from Windows 12

N-up

Macintosh 35

Windows 18

overlay 22

poster 21

scaling 20

watermark 21

printer properties, set

Linux 31

Macintosh 34

Windows 13, 23

printer resolution, set

Macintosh 35

Windows 15

printer software

install

Linux 28

Macintosh 32

Windows 4

uninstall

Linux 30

Windows 11

printing

booklets 19

double-sided 20

## S

setting

darkness 15

favorites 17

image mode 15

resolution

Macintosh 35

Windows 15

toner save 15

true-type option 15

software

install

Linux 28

- Macintosh 32
- Windows 4
- reinstall
  - Windows 10
- system requirements
  - Linux 27
  - Macintosh 32
- uninstall
  - Linux 30
  - Windows 11
- status monitor, use 25
- system requirements
  - Linux 27
  - Macintosh 32

## T

- toner save, set 15

## U

- uninstall, software
  - Linux 30
  - Windows 11

## W

- watermark
  - create 21
  - delete 21
  - edit 21
  - print 21

